

Instructions for installation, handling operation and maintenance – ENG

eTronic 7000

Electric boiler for heating and preparation of sanitary water with processor handling control

Content

1. Explanation of symbols

2. Device data

- 2.1. Overview of types
- 2.2.1 Declaration of Conformity
- 2.2.2 Proper use
- 2.3 Installation instructions
- 2.4 Instructions for operation
- 2.5 Use of chemicals
- 2.6 Norms, regulations and standards
- 2.7 Tools, materials and auxiliary means
- 2.8 Minimum spacing and hazardous means
- 2.9 Product description
- 2.11 Scope of delivery
- 2.12 Type panel
- 2.13 Dimensions and technical data

3. Transport

4. Installing

- 4.1 Caution when installing
- 4.2 Distance
- 4.3 Disassembly of the front cover
- 4.4 Installation of the boiler
- 4.5 Introduction of hydraulic connectors
- 4.6 Filling and checking the installation
 - 4.6.1 Filling the boiler with water and testing
 - 4.6.2 Air discharging of the pump and unblocking
 - 4.6.3 Discharge air from the boiler and installation
- 4.7 The systems on which the eTronic 7000 boiler can be connected

5. Electrical connector

- 5.1 Position of the entry for the introduction of the cable
- 5.2 Connecting the cable
- 5.3 Connection scheme
- 5.4 Power cable connection scheme
- 5.5 External control of the boiler (room thermostat)

6. Putting into operation

- 6.1 Before putting into operation
- 6.2 First putting into operation
- 6.3 Record on putting into operation

7. Handling operation of the heating regime and the preparation of sanitary water of heating

- 7.1 Instructions for operation
- 7.2 Overview of the setting elements
 - 7.2.1 Functions of device
 - 7.2.2 Basic settings
 - 7.2.3 Heating regime
 - 7.2.4 Symbols on the display
 - 7.2.5 Symbols and warning codes
 - 7.2.6 Symbols and error codes
- 7.3 Heating regulation
 - 7.3.1 Regulator of room temperature
 - 7.3.2 Cease of heating
- 7.4 Putting the boiler out of operation
- 7.5 Sanitary water preparation regime
- 7.6 Regime of heating and preparation of sanitary water

8. Cleaning and maintenance

9. Environmental protection and disposal into waste

10. Faults and their remedy

11. Instructions for designing

12. Product data sheet (in accordance with EU regulation no. 811/2013)

1. Explanation of symbols and instructions for safe work

1.1 Explanation of symbols Instructions and warnings



Warnings are marked with a gray triangle in the text, and are framed.



The risk of electric shock is indicated by the symbol of lightning in the triangle, and framed.

Signal words at the beginning of the safety note indicate the manner and severity of the consequences that threaten unless there are applied measures to prevent danger.

- **NOTE** means that minor material damages may occur.
- **CAUTION** means that minor or medium-sized injuries may occur.
- **WARNING** means that serious injuries can occur.
- **DANGER** means that serious injuries can occur.

Important information



Important information, which does not pose a danger to people or things, is indicated by the symbol shown in the text below.

They are limited by lines, above and below the text.

Other symbols

Symbol	Meaning
▶	Step of the action
→	Guidance to other places in the document or to other documents.
•	Listing/Entry from the list
–	Listing/Entry from the list (2.)

Table 1

1.2 Instructions for safe work General safety instructions

Failure to follow the safety instructions can result in serious injuries - as well as to deadly consequences, material damages and damage to the environment.

- Provide a professional examination of the electrical installation before installing the device.
- All electrical operations must be carried out by a person authorized to carry out electrical operations, according to the relevant regulations.
- Ensure that putting into operation, as well as maintenance and repairs are carried out by an authorized service centre.
- Provide technical reception of the installation in accordance with the relevant regulations.

Danger due to not respecting one's own safety in case of an emergency, eg. in the event of fire.

- Never expose yourself to life threatening situations. Your own safety is always a priority.

Damage caused by wrong handling

Handling errors can lead to injury of persons and/or damage to the installation.

- Make sure that only people who know how to handle properly the device have access to it.
- Installation and putting into operation, as well as maintenance and repair, must only be carried out by an authorized service centre with appropriate authorization for electrical works.

Installation and putting into operation

- Leave the installation of the device only to an authorized service centre.
- Always start the boiler only if the installation is at an appropriate pressure and the operating pressure is correct. Do not close the safety valves in any case in order to avoid damage caused by too high pressure. During heating, the water can leak on the safety valve of the hot water circuit and hot water pipe.
- Install the device only in a room where freezing cannot occur.
- Do not store flammable materials or liquids near the device.
- Keep a safe distance according to applicable regulations.

Life-threatening danger from electric shock

- Leave the introduction of electrical connection to an authorized service technician. Follow the connection scheme.
- Before all works: disconnect the electric power supply. Secure yourself from accidental turning on.
- Do not install this device in wet rooms.

Inspection / maintenance

- Recommendation for the user: Make a maintenance contract with an authorized service centre, that will perform annual maintenance and control checks.
- The user is responsible for the safety and environmental acceptability of the installation.
- Follow the safety instructions for safe work which are to be found in the chapter '**Cleaning and maintenance**'.

Original spare parts

No liability can be claimed for damages arising because of the spare parts which are not supplied by the manufacturer.

- Use only original spare parts.

Material damages from freezing

- In the event of a risk of freezing, drain the water from the boiler, tank and pipes of the heating system. The risk of freezing does not exist only when the entire installation is dry.

Instructions for service technicians/centres

- Inform the users about the operating mode of the device and maintenance.
 - Inform the users that they must not make any changes or repairs on their own.
 - Warn the users that children without adult supervision should not be kept near the heating installation.
 - Fill in and submit the "Putting into operation" and "Take-over Minutes" contained in this document.
- ▶ Hand over the technical documentation to the user.

Disposal into waste

- Dispose of packaging in an environmentally acceptable manner.
- Dispose of the device in an environmentally acceptable manner at an authorized place.

Cleaning

- Clean the device with a damp cloth from the outside.

2. Device data

These instructions contain important information on safe and professional installation, putting into operation and maintenance of the boiler.

These instructions are intended for installers who, on the basis of their expertise and experience, have knowledge in working with heating installations.

2.1 Overview of types

These instructions apply to the following types:

eTronic 7000	6 ÷ 24kW
---------------------	----------

2.2.1 Declaration of Conformity

We declare that the devices have been tested in accordance with Directives 2006/95/EC (Low Voltage Directive, LVD) and 2004/108/EC (Electromagnetic Compatibility Directive, EMC).

2.3 Installation instructions



Use only original spare parts of the manufacturer or spare parts approved by the manufacturer. No liability is assumed for damages arising because of the spare parts that are not supplied by the manufacturer.

When installing a heating installation, follow the following instructions:

- valid construction regulations
- regulations and norms on the safety and technical equipment of the heating installation
- changes at the place of installation in accordance with applicable regulations

2.4 Instructions for operation

When working with the heating installation, observe the following instructions:

- The boiler should work in the working area up to a maximum temperature of 80 °C, a minimum pressure of 0.8 bar and a maximum pressure of 2.2 bar, and should be monitored regularly.
- The boiler should only be handled by adults who are familiar with the instructions and the work of the boiler.
- Do not close the safety valve.
- Inflammable objects must not be placed on or near the boiler (within the safety distance).
- Clean the surface of the boiler only with non-combustible materials and agents.
- Do not keep inflammable things in the room intended for installation of the boiler (eg. petroleum, oil).
- No cover must be opened during operation.
- Keep a safe distance according to the local valid regulations.

2.5 Anti-freezing agents and inhibitors

It is not allowed to use anti-freezing agents or inhibitors. If the use of the anti-freezing agent cannot be avoided, there should be used anti-freezing products that are permitted for heating installations.



Use of anti-freezing agents:
 ► shortens the lifetime of the boiler and its parts
 ► reduces the transfer of heat

2.6 Norms, regulations and standards

The product is in compliance with the following norms and regulations:

- EN 50110-1:2003 – handling and operation with electrical installations
- EN 55014:2001 – electromagnetic compatibility - conditions for household devices, electrical devices and similar devices
- EN 60 335-1+ed.2:2003 - electrical household devices
- EN 60 335-1+ed.2 zm A1:2005 - electrical household devices
- EN 61000-3-2 ed.3:2006 - electromagnetic compatibility (EMC) – the limit for the harmonic current emission
- EN 61000-3-3:1997 - electromagnetic compatibility (EMC) – Law on the limitation of voltage fluctuations and flickering of the low-voltage partition network

Certificates provided by accredited laboratory no.:
 LVD standards: 08131402 i.no: I-005 10.01.2014
 EMC standards: 071375680 i.no: I-005 10.01.2014

2.7 Tools, materials and auxiliary means

For installation and maintenance of the boiler, standard tools from the field of heating, plumbing and electrical installations are required.

EC Declaration of Conformity
In accordance with EN ISO 17050-1:2004

N 005

manufacturers / company name: **MIKOTERM DOO**
 Europe, Serbia, 18205 Niska Banja, Sindjeliceva 4

for product: Electrical boiler for central heating systems
 model: **eTronic 7000**
 types:

- eTronic 7000 6kW
- eTronic 7000 9kW
- eTronic 7000 12kW
- eTronic 7000 18kW
- eTronic 7000 24kW

on the basis of test reports from authorised laboratory declaration confirms that the objects of declaration described above is in conformity with requirements of the following documents:

2006/95/EC 2004/108/EEC	LOW VOLTAGE DIRECTIVE (LVD) ELECTROMAGNETIC COMPATIBILITY (EMC)
----------------------------	--

applied LVD standards:
 - EN 60335-1:2010

applied EMC standards:
 EN 55014-1:2010+2010/A1:2010+2010/A2:2012
 EN 61000-3-2:2008+2008/A1:2011+2008/A2:2011
 EN 61000-3-3:2009
 EN 55014-2:2009
 EN 61000-4-2:2009
 EN 61000-4-4:2008+2008/A1:2012+2013
 EN 61000-4-5:2008
 EN 61000-4-6:2010
 EN 61000-4-11:2008

Manufacturer declares that appliance received above is tested in authorised laboratory. After testing manufacturer received test reports:
 - for LVD standards : 0813001801 i.no: N-005
 - for EMC standards : 0713005601 i.no: N-005

issued date: 10.01.2014

Akcionarsko društvo za ispitivanje kvaliteta "KVALITET" Niš
 Акционарско друштво за испитивање квалитета "КВАЛИТЕТ" Ниш
 Joint-stock company for quality testing "KVALITET" Niš

IZJAVA O USAGLAŠENOSTI
 STATEMENT OF CONFORMITY

Proizvod:
Product:

Broj:
No.

ELEKTRIČNI KOTAO

10813001801

Tip/model:
Type/Model:

eTronic 7000 6kW; eTronic 7000 9kW; eTronic 7000 12kW; eTronic 7000 18kW;
 eTronic 7000 24kW

Robna marka:
Trademark:

Podnosilac:
zahteva/isporučilac:
Applicant/Supplier:

MIKOTERM D.O.O.
 18205 NISKA BANJA
 SINDELICEVA 4

Proizvođač:
Manufacturer:

MIKOTERM
 18205 NISKA BANJA /SRBIJA
 SINDELICEVA 4/18205 NISKA BANJA

Izveštaj o ispitivanju:
Test report:

081400150

Na osnovu gore navedene dokumentacije utvrđeno je da gore navedeni proizvod zadovoljava zahteve Pravilnika o električnoj opremi namenjenoj za upotrebu u okviru određenih granica napona (Sl. glasnik RS, 13/2010).
 On the basis of the above mentioned documentation it is found that above mentioned product fulfills the requirements of the Rulebook on Electrical Equipment designed for Use within Certain Voltage Limits (Official Gazette RS, 13/2010).

Nastale promene u specifikaciji, tipu/modelu, komponentama, električnim karakteristikama proizvoda koji utiču na usaglašenost sa navedenim Pravilnikom moraju se prijaviti "Kvalitet"-u a.d. Niš.
 Any changes occur in the specification, type/model, components of the design, electrical construction which may influence on conformity to the above mention Rulebook, shall be forwarded to "Kvalitet".

Mesto i datum izdavanja:
Place and date:
Niš, 10.01.2014.

 Vladimir Vukašinović, dipl.inž.

Ovaj dokument važi samo uz proizvode ili robu koji su istovetni s ispitanim uzorkom.

Bul. Svetog Cara Konstantina 82-86, Niš 18000, Srbija. Tel: (018)550-766, 550-624, Fax: (018)550-636, 550-068
 e-mail: office@kvalitet.co.rs, http://www.kvalitet.co.rs

Akcionarsko društvo za ispitivanje kvaliteta "KVALITET" Niš
 Акционарско друштво за испитивање квалитета "КВАЛИТЕТ" Ниш
 Joint-stock company for quality testing "KVALITET" Niš

IZJAVA O USAGLAŠENOSTI
 STATEMENT OF CONFORMITY

Proizvod:
Product:

Broj:
No.

ELEKTRIČNI KOTAO

10713005601

Tip/model:
Type/Model:

eTronic 7000 6kW; eTronic 7000 9kW; eTronic 7000 12kW; eTronic 7000 18kW;
 eTronic 7000 24kW

Robna marka:
Trademark:

Podnosilac:
zahteva/isporučilac:
Applicant/Supplier:

MIKOTERM D.O.O.
 18205 NISKA BANJA
 SINDELICEVA 4

Proizvođač:
Manufacturer:

MIKOTERM D.O.O.
 SRBIJA

Izveštaj o ispitivanju:
Test report:

071400470

Na osnovu gore navedene dokumentacije utvrđeno je da gore navedeni proizvod zadovoljava zahteve Pravilnika o elektromagnetnoj kompatibilnosti (Sl. glasnik RS, 13/2010).
 On the basis of the above mentioned documentation it is found that above mentioned product fulfills the requirements of the Rulebook on Electromagnetic Compatibility (Official Gazette RS, 13/2010).

Nastale promene u specifikaciji, tipu/modelu, komponentama, električnim karakteristikama proizvoda koji utiču na usaglašenost sa navedenim Pravilnikom moraju se prijaviti "Kvalitet"-u a.d. Niš.
 Any changes occur in the specification, type/model, components of the design, electrical construction which may influence on conformity to the above mention Rulebook, shall be forwarded to "Kvalitet".

Mesto i datum izdavanja:
Place and date:
Niš, 09.01.2014.

 Vladimir Vukašinović, dipl.inž.

Ovaj dokument važi samo uz proizvode ili robu koji su istovetni s ispitanim uzorkom.

Bul. Svetog Cara Konstantina 82-86, Niš 18000, Srbija. Tel: (018)550-766, 550-624, Fax: (018)550-636, 550-068
 e-mail: office@kvalitet.co.rs, http://www.kvalitet.co.rs

2.8 Minimum spacing and flammability of construction materials

Depending on the applicable regulations, other minimum distances, other than those mentioned below, may be valued.

- ▶ Follow the regulations on electrical installations and the minimum distances in force in the countries concerned.
- ▶ The minimum distance for heavily flammable and self-extinguishing materials is 200 mm.

Flammability of component elements		
A	non-flammable	
A1:	non-flammable	Asbestos, stone, ceramic wall tiles, baked clay, mortar, (without organic additives)
A2:	with a small amount of inflammable additional elements (organic components)	Panels made of plasterboard, panels made of basac felt, glass fibres, panels made of ACUMIN, ISOMIN; RAJOIT, LOGNOS, VELOX and HERACLIT
B	flammable	
B1:	hardly inflammable	Beech, oak, veneered wood, felt, panels made of HOBREX, VERZALIT and UMAKART
B2:	normally flammable	Pine, larch and spruce, veneered wood
B3:	flammable	Asphalt, cardboard, cellulosic materials, waterproofing tape, panels of chipboard, cork, polyurethane, polystyrene, polyethylene, floor fibrous

Table 2: Flammability of component elements according to DIN 4102

2.9 Product description

The basic components of the boiler are:

- Container of the boiler with associated components
- Frame of the device and the shell of the boiler
- Control unit
- Pump
- Expansion container (according to capacity)
- Processor board and electronics of the boiler
- Water pressure sensor
- Safety valve

The boiler can be installed as an integral part of the central heating system, floor heating, and hybrid or accumulation systems.

The boiler consists of a welded housing made of steel sheet with thermal insulation. The boiler is fixed to the wall by using a frame and the delivered installation kit. Built-in thermal insulation in the shell of the boiler reduces loss of heat. At the same time, the insulation also protects against noise.

The safety elements (valve for discharging of air, fuse of the control surface, safety temperature limiter) are located at the top of the boiler.

Depending on the type of boiler, electric heaters of different power are used. The power of the boiler can be precisely adjusted. The setting of different levels of power of the boiler is done by using the buttons on the dashboard. The number of levels of power is given in the table (→ chapter 2.13.2).

- | | |
|---|--|
| <p>1 UL Return line of the boiler
 2 IZ Starting line of the boiler
 3 Exchanger of the boiler
 4 Electric heaters
 5 Expansion container Zilio 8l
 6 Pump Wilo Para MSL/6-43/SC
 7 Valve for discharging of air (on the pump)
 8 Safety valve 3 bar (on the pump)
 9 Drain faucet (on the pump)
 10 Automatic air discharger (on the exchanger of the boiler)
 11 Automatic fuses</p> | <p>12 Clamp for thermostat, boiler temperature sensor, motor valve
 13 Network board MMB2408_VX4
 14 Relay board PLR_V3B
 15 Boiler temperature sensor (KTY81-110)
 16 Safety thermostat 95 °C (NO)
 17 Control panel with display (EK_CPU_1_3)
 18 Elastic hose for connection of expansion vessel
 19 Elastic drainage hose of valve for discharging of air
 20 Elastic drainage hose of safety valve
 21 ON / OFF switch
 22 Hydraulic pressure sensor (on the pump)</p> |
|---|--|

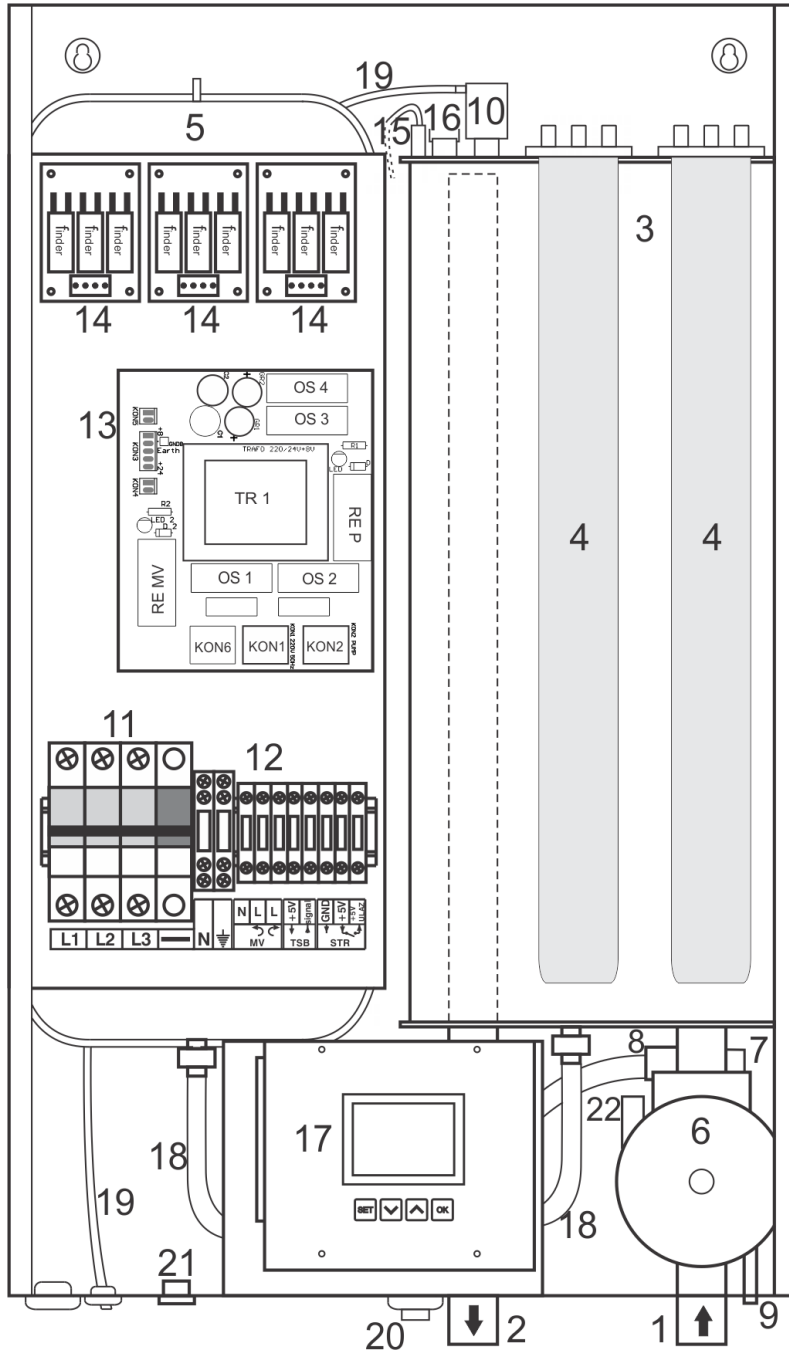

Image 1: Boiler Components

2.10 Waste disposal

- ▶ Dispose of packaging in an environmentally acceptable manner.
- ▶ Take care that the components are replaced in an environmentally acceptable manner.

2.11 Content of packaging

When delivering the boiler, comply with the following:

- ▶ Make sure that the packaging is undamaged on delivery.
- ▶ Check whether the delivery is complete.

Part	number of pieces
Boiler eTronic7000	1
Installation kit	1
Manual	1

2.12 Factory tile

The factory tile is located on the outside of the boiler and contains the following technical data:

- type of boiler
 - serial number/catalog number
 - power
 - input power
 - maximum temperature
 - work pressure
 - volume of boiler's container
 - mass
 - electric power supply
 - level of protection
 - manufacturer
-

2.13 Dimensions and technical data

2.13.1 Dimensions and technical data for boiler eTronic 7000

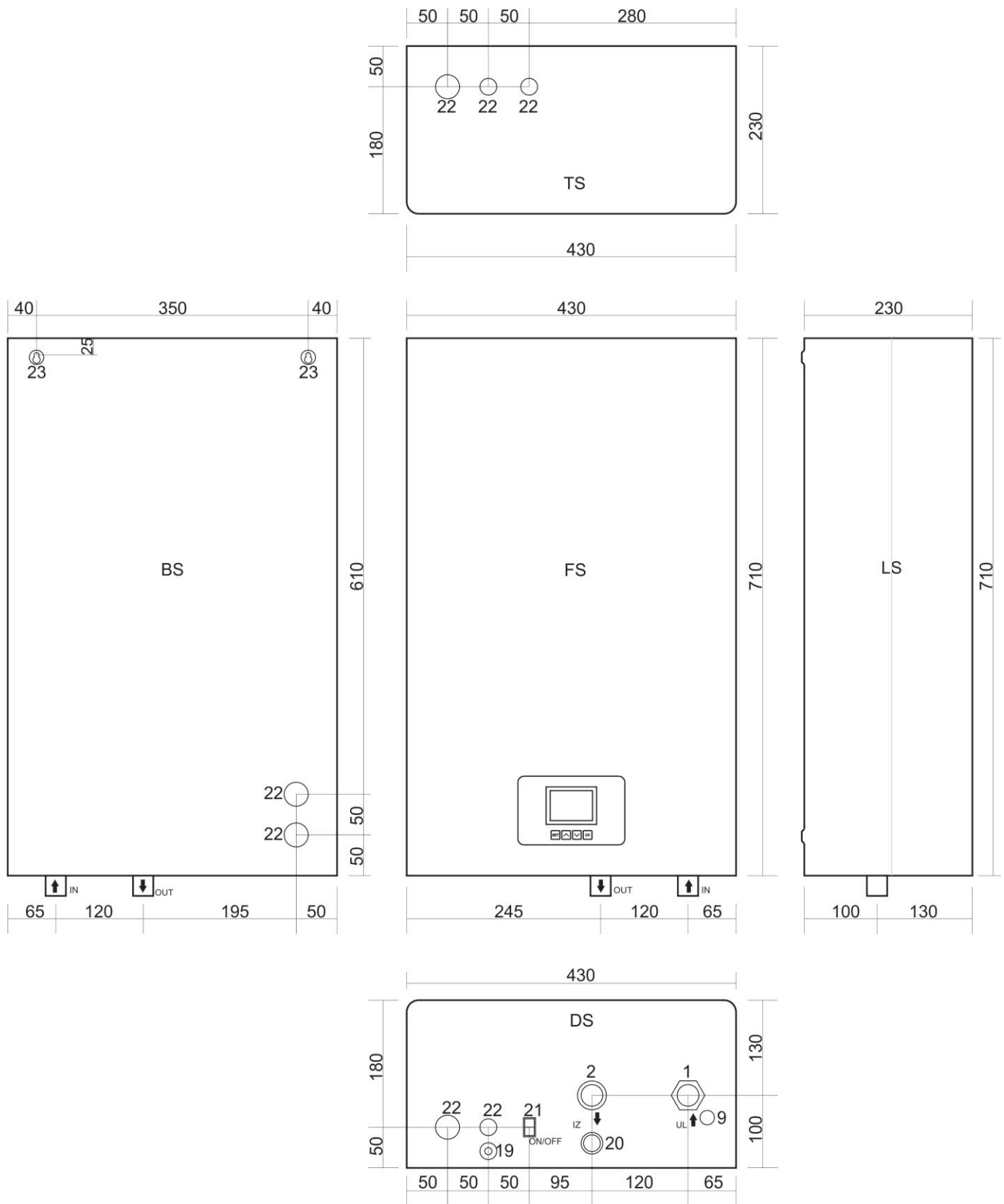

DS – Bottom side; FS – Front side; LS – Left side; TS – Upper side; BS – Back side

Image 2: Dimensions and connectors

2.13.2 Technical data

	Unit	eTronic7000	eTronic7000	eTronic7000	eTronic7000	eTronic7000
Power	kW	6	9	12	18	24
Degree of utilization	%	99				
Number of degrees of power		3	6	6	9	9
Division of degrees of power	kW	3×2	6×1,5	6×2	9×2	9×2,7
Network voltage	V AC	3N ~ 400/230V 50Hz				
Protection level		IP40				
Required fuses for three phase power supply	A	3×16	3×20	3×25	3×32	3×40
Minimum cable cross-section for three phase power supply	mm ²	5×2,5	5×2,5	5×4	5×4	5×6
Required fuses for single phase power supply	A	1×25	1×40	-	-	-
Minimum cable cross-section for single phase power supply	mm ²	3×4	3×6	-	-	-
Safety valve	bar	3				
Max. permissible operating pressure	bar	2,2				
Min. permissible operating pressure	bar	0,8				
Max. temperature of the boiler	°C	80				
Volume of water in the boiler	l	12,5				
Volume of expansion container	l	8				
Connector of starting line	zoll	3/4" (DN20)				
Connector of return line	zoll	3/4" (DN20)				
Mass of device (without water)	Kg	25				
Dimensions	mm	710×430×230 (H×W×L)				
Processor unit		EK_CPU_1_3				

Table 3: Technical data of the device eTronic 7000

3. Transport



NOTE: Transport damage

- ▶ Pay attention to the transport instructions that are written on the packaging.
- ▶ Use a suitable transport vehicle, e.g. trolley for bags with clamp tape. The product should be in the lying position during the transport.
- ▶ Avoid impacts or crashes.

- ▶ Put the packed boiler on the trolley for bags, if necessary, secure it with the clamp strip and transport it to the place where it will be set.
 - ▶ Remove packaging accessories.
 - ▶ Remove boiler's packaging material and dispose of it in an environmentally acceptable manner.
-

4. Installation of the device



CAUTION: Human or material damages caused by improper installation!

- ▶ Never install the boiler without an expansion container (AG) and a safety valve.
- ▶ The boiler must not be installed in the protective zone of the wet area and the area where a bathtub is located.



NOTE: Material damages from freezing!

- ▶ The boiler may only be installed in rooms where freezing cannot occur.

4.1 Be careful about the following before installation



NOTE: Material damages caused by non-compliance with further instructions!

- ▶ Follow the instructions for the boiler and all installed components.

Before installing, keep an eye on the following:

- All electrical connections, protection measures and fuses should be carried out by an authorized person, complying with all applicable norms and regulations as well as local regulations.
- The electrical connection must be carried out according to connection schemes.
- After proper installation of the device, carry out the grounding
- Switch off the electric power before opening and all operations
- Unprofessional and unauthorized attempts of connection can cause material damages to the device and lead to dangerous electric shocks

4.2 Distance



DANGER: Fire hazard due to flammable materials or liquids!

- ▶ Do not dispose of flammable materials or liquids near the boiler.
- ▶ Inform the user about applicable regulations of minimum distances from highly flammable materials (→ chapter 2.8, page 7).

- follow the regulations on electrical installations and the minimum distances which are in force in the countries concerned
- set the boiler on the wall in such a way that there remains the minimum free space as shown in Image no.3

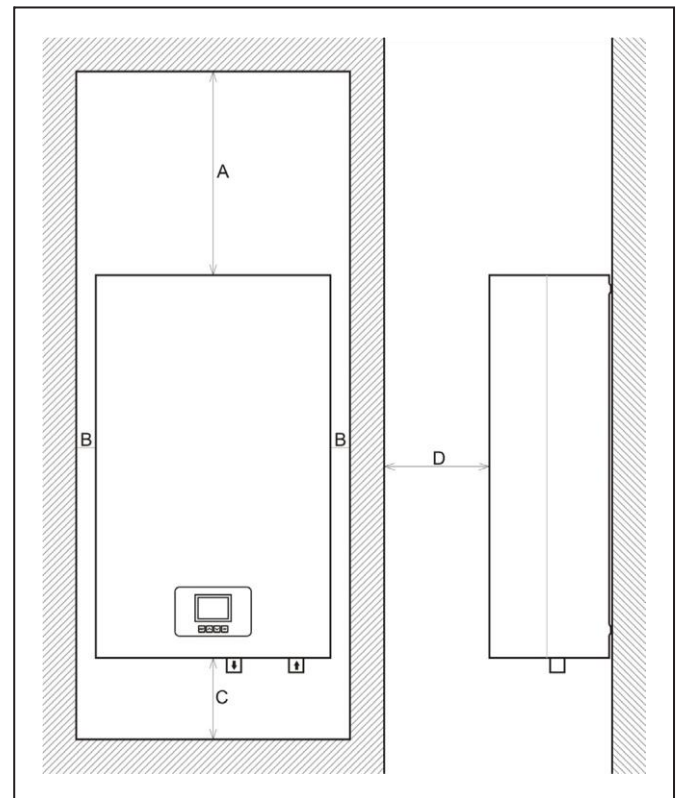

A = 500mm/ B = 50mm / C = 200mm/ D = 500mm

Image 3: Minimum distances during installation

4.3 Disassemble the front cover of the boiler

The shell of the boiler can be removed for easy handling and installation.

- ▶ Unscrew the screws on the top cover.
- ▶ Unscrew the screws on the bottom cover.
- ▶ With a slight pulling towards you, disassemble the front shell of the boiler.

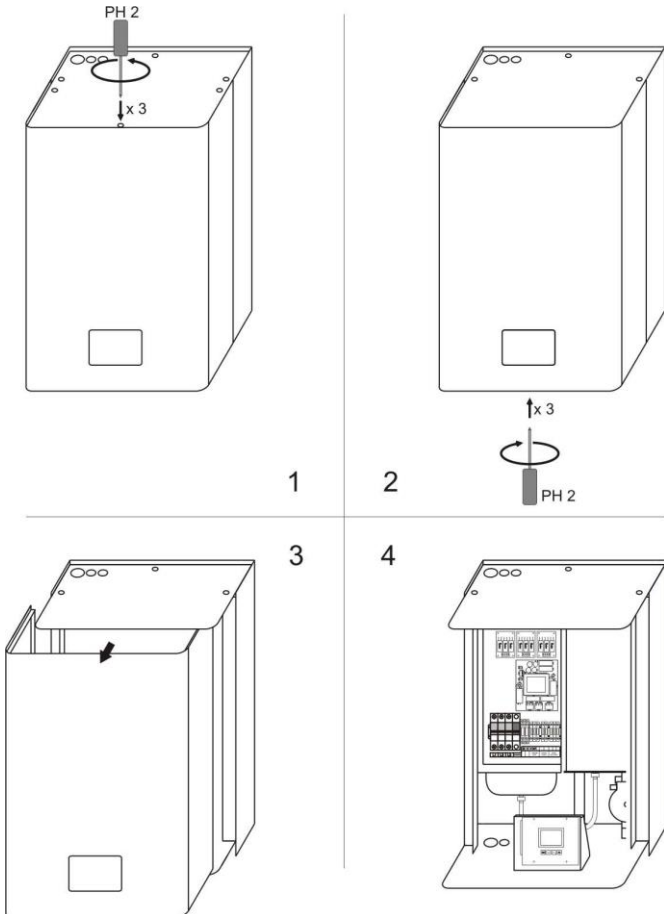

Image 4: Opening of the boiler (disassembling of the front shell)

4.4 Installation of the boiler



NOTE: Material damages caused by improper installation onto wall!

- ▶ Suitable material for fixing should be used

This chapter describes installation of the boiler on the wall.

- ▶ Draw the positions of openings for drilling for the installation kit according to the dimensions shown in Image 2.
- ▶ Take care when marking the openings for the installation in order to allow the boiler to stand vertically.
- ▶ Drill the holes in the wall with an adequate drill.
- ▶ In the drilled holes, place the plastic anchors that are part of the package of the device (or the anchors that are adequate for some non-standard type of wall).
- ▶ Then screw in the bolts that are supplied together with the anchors (or some other) so that they stick out of the wall min 5mm and maximum 10mm.
- ▶ Carefully attach the device to the wall, make sure that the boiler is installed vertically.
- ▶ Fix the boiler from the inside with the nuts from the installation kit.

4.5 Introduction of hydraulic connectors



NOTE: Material damages caused by throughput connectors!

- ▶ Install the connection lines without connecting to the connectors of the boiler.

Connect the heating lines as follows:

- ▶ Connect the return line to the IN connector.
- ▶ Connect the starting line to the OUT connector.

4.6 Fill the installation and check the impermeability.



Before filling the system, the boiler must be connected to the electrical installation and switched on via the ON/OFF switch on the bottom side of the boiler to the STAND BY mode in order to monitor the value of pressure in the installation.

4.6.1 Fill the boiler with water (demineralized water is recommended) and test the welds and seals

- ▶ The impermeability must be tested before putting the boiler into operation.



DANGER: Injuries and/or material damages can occur by exceeding the pressure during the testing of impermeability!

High pressure can damage the control and safety devices as well as the tank itself.

- ▶ Fill the boiler with pressure that corresponds to the pressure of the opening of the safety valve.
- ▶ Observe the maximum pressure of the built-in components.
- ▶ After checking the impermeability, re-open the valves.
- ▶ Ensure that all control and safety parts for pressure control work properly.



DANGER: Danger to health due to mixing drinking water!

- ▶ Be sure to follow national regulations and norms to avoid mixing drinking water (eg. with water from heating installations).
- ▶ Please follow EN 1717.



NOTE: Damages to the installation due to poor water quality! Depending on the properties of the water, the heating installation may be damaged by corrosion or by the formation of limescale.

- ▶ Follow the requirements for water for filling according to VDI 2035, i.e. project documentation and the catalog.

- ▶ Check the pre-pressure of the expansion container.
- ▶ Open the charging and discharging tap.
- ▶ Fill the boiler slowly. Follow the pressure on the display

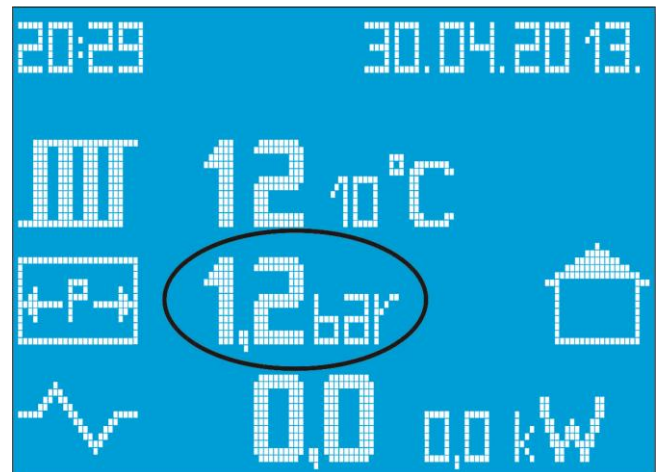

Image 5: Display with highlighted pressure



NOTE: Material damages caused by temperature stress.

If you fill the boiler in a warm/hot condition, the temperature stresses can cause cracks due to straining. The boiler will start to leak water.

- ▶ Fill the boiler only in cold condition (the temperature of starting line may be maximally 40°C).
- ▶ Fill the boiler only through the quick valve on the boiler's pipe installation (return line).

Close the tap when the operating pressure is reached.

- ▶ Discharge the air from the boiler through the valve for air discharging (→ image 5 and image 6).
- ▶ Discharge the air from the installation via the valve on the radiator.
- ▶ When the operating pressure is lowered by discharging of air, the water must be refilled.
- ▶ Test the impermeability according to local regulations.
- ▶ After checking the impermeability, open all the items that you closed because of the filling.
- ▶ Make sure all the security elements work correctly.
- ▶ If the boiler is tested for impermeability and no leakage has been detected, set the correct operating pressure.

- ▶ Remove the hose from the tap for charging and discharging.
- ▶ Enter the values of operating pressure and water quality in the operating manual.

At first or repeated charging or when replacing water

- ▶ Follow the requirements for water for filling.

4.6.2 Air discharging of the pump for heating and unblocking

▶ The pump in this device has an automatic air discharger and no action is required for air discharging from the pump. If not fully vented, access manual venting according to the instructions in **Chapter 11**.

4.6.3 Discharge air from the boiler

- ▶ Carefully, by using the screw on the air discharger, release the valve and discharge air from the boiler. This valve is also automatic so that if you comply with the rule of slow filling of the installation and the boiler, no additional manual discharging will be required.

4.7 The systems on which the eTronic 7000 boiler can be connected

- All systems for space heating that are designed to 80/60 temperature regime (or lower)
- Closed heating systems.
- Systems where there exists a solid fuel boiler



ATTENTION! When connecting the boiler to such as system, it is obligatory to take care that both pumps in the system push water in the same direction so that the flows do not collide.

Possible too high hydraulic straining of the system and breaking of some components as well.

- It can be used as a device for heating sanitary water in accumulation boilers through an exchanger.
- It may also be used in certain technological processes provided that there is no need for water temperature over 60°.
- It must not be used for direct heating of sanitary wate.

5. Electrical connector



DANGER: Life danger from electric shock!

- ▶ Perform electrical works only with the necessary qualifications.
- ▶ Before opening the device, disconnect the network voltage from all poles and ensure that it is not activated again.
- ▶ Follow the regulations for installation.



When connecting the boiler to the electrical installation, take care of the connection scheme and connection plans. Observe required cable cross-sections and fuse power outside the boiler.



This device is intended for connection to a three-phase network (3N~400/230)

5.1 Position of the entry for the introduction of the power cable

This device is equipped with three (3) sets of entries for introduction of power cables.

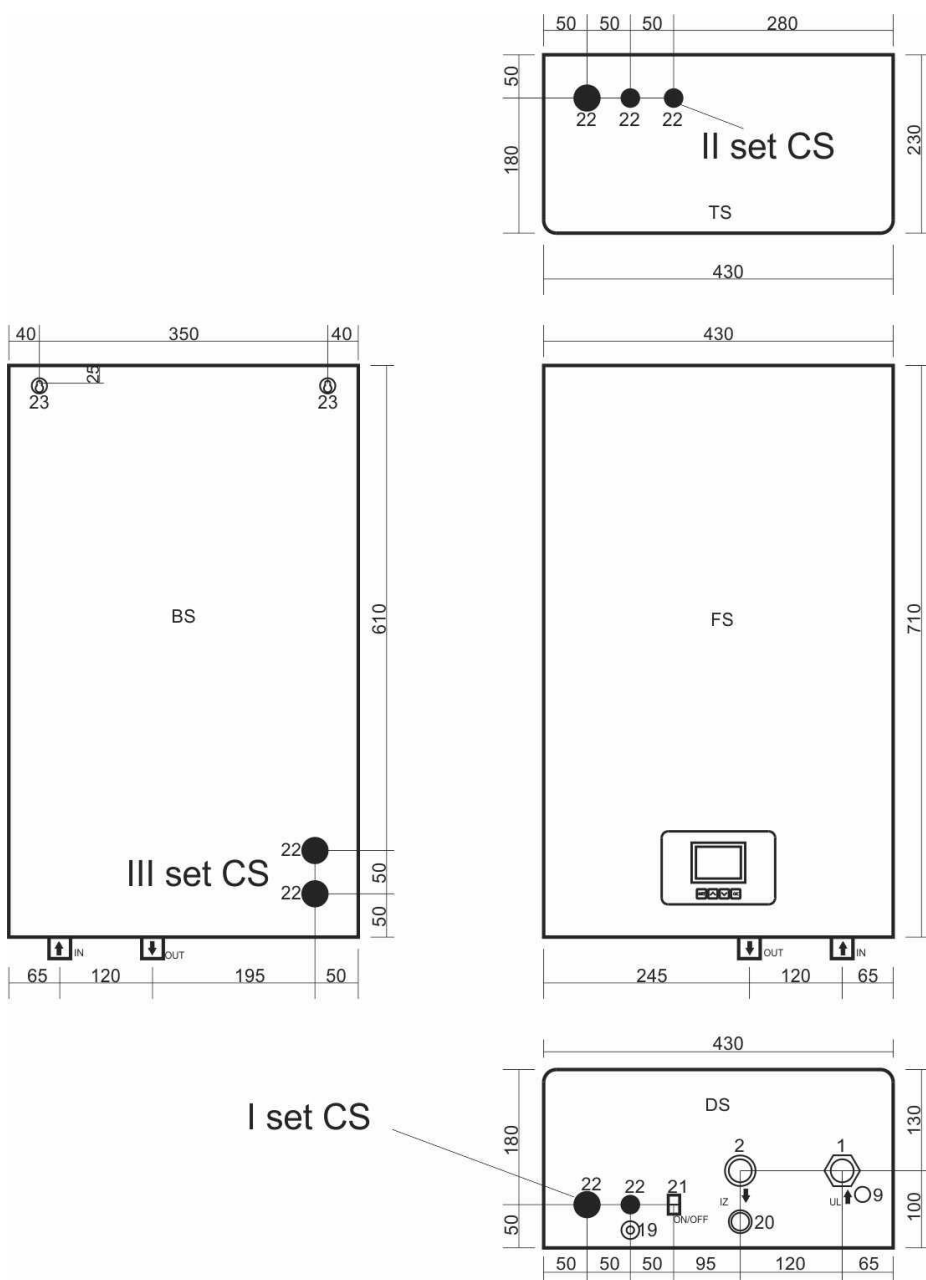

I set of entries for introduction of power cables (main set) is located on the bottom side of the device. They are located on the bottom panel of the device in the rear left corner. (→ see image 6) They are intended for connection of the device when the power cable comes from the bottom side of the boiler.

II set of entries for introduction of power cables is located on the upper side of the boiler and also in the rear left corner (→ see image 6). They are intended for connection of the device when the power cable comes from the upper side of the device.

III set of entries for introduction of power cables is placed from the inside of the device on its rear side, and it is intended when cables in the wall are prepared on time and when the place for the boiler is prepared. They allow the power cable to directly enter from the wall into the boiler. When the front cover is removed, in the bottom left side can be seen two openings of dimensions of 28 mm and placed one above the other. This way of connecting provides only aesthetic function because the cables are not visible. (→ see image 6).

I set CS / II set CS / III set CS – Position of the first set of Cable holders

Image 6: Display of positions of entries of cables on the boiler

5.2 Connecting the cable

- Connection is performed according to the installationscheme in the image number 7.
- Instead of the conventional regular clamp for connecting the power cable, there are three-pole automatic fuses in the boiler, into which the power cable is introduced. The three-pole set of automatic fuses has been upgraded with a remote voltage trigger so that a safety circuit is achieved which, in addition to short-term electricity protection, responds to thermal overload (the signal from the safety thermostat activates the voltage trigger) and at the same time interrupts the supply of all three phases into the device.
- The phase conductors are connected to a three-pole fuse (L1, L2, L3)



ATTENTION! When connecting the phase conductors, be sure to tighten the screws in the automatic fuses in order to achieve the best possible connection between the cable and the clamp.

- The neutral (zero) line is connected to the corresponding regular clamp (N) located on the right side of the fuse set with the voltage trigger. The regular clamp of zero line is blue.
- Connect the line for grounding to the regular clamp which is marked with the sign for grounding. The regular clamp of the line for grounding of the device is green and yellow.



NOTE: The remote voltage trigger is factory-connected within the safety set of the device and NO cable is connected to it subsequently.



NOTE: The room thermostat is connected to the additional regular clamps (5V, IN) and it interrupts the voltage of 5V DC which comes from the processor panel of the boiler.

- Room thermostat is only necessary if the boiler is used for heating and for the preparation of sanitary water. In the ONLY heating mode, a room thermostat is not necessary, but it is recommended to save energy.

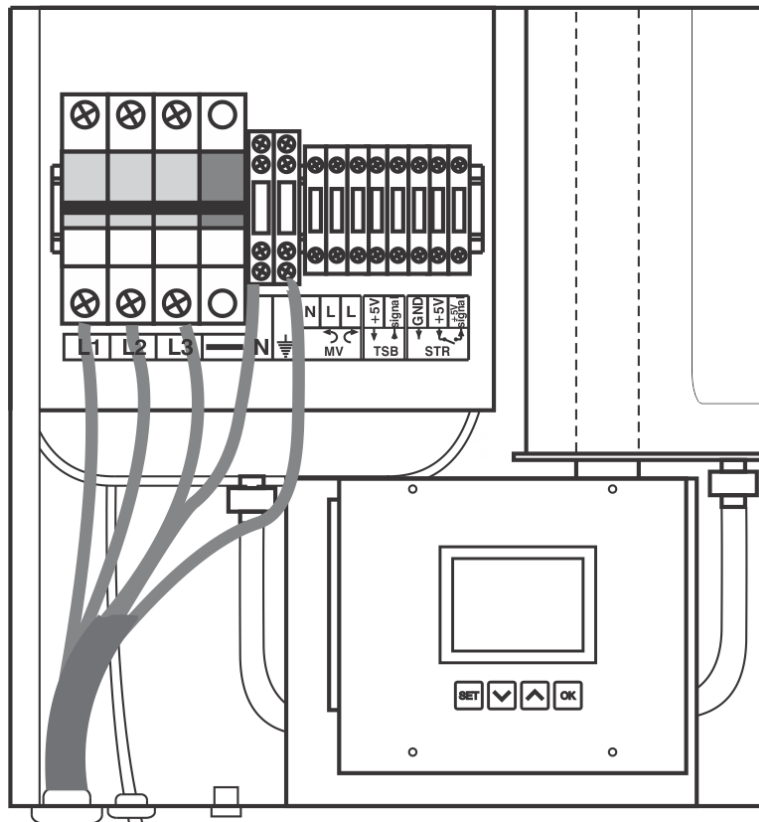

Image 7: Scheme of connection of power cable

- When introducing a power cable into the boiler, through any selected set of entries for introduction, carefully pull through the cable to the three-pole automatic fuses to avoid damaging the cable sets inside the device.



NOTE! The connection of this device must be carried out by a person that is qualified to perform this kind of work.

- When you are finished with the connection of the power cable and room thermostat, it is necessary to lift the fuse set together with the remote voltage trigger before closing the device, that is, before installing the front cover, in order to ensure the power supply to the boiler.

5.3 Connection scheme

i All of the above-mentioned cable cross-sections are minimum cross-sections. The sections to be set depend on the length of the line and the method of setting.

► Dimension the cable cross-sections according to local regulations.

Legend	
DA	Remote voltage trigger
3P A	Three-pole automatic fuse
ST	Safety thermostat Klikson
STR	Room thermostat
+5V, +5V signal,	Connection clamps of the room thermostat ATTENTION: 5V DC (GND is only for EST 113 R5)
GND	
P1	Main switch ON/OFF
Re1/Re2	Relay pumps / Relay motor valve
CP / MV	Pump / Motor valve
SP	Pressure sensor

Legend	
TS/TSB	Temperature sensor of the boiler
OS 1	Electric fuse 230V T500mA
OS 2	Electric fuse 230V T2A
OS 3	Electric fuse 24V T500mA
OS 4	Electric fuse 8V T500mA
Re1.1, Re2.1, Re1.3	Relay heater on the panel PLR V1.1
Re2.1, Re2.2, Re2.3	Relay heater on the panel PLR V1.2
Re3.1, Re3.2, Re3.3	Relay heater on the panel PLR V1.3
G1, ..., G9	Electric heaters

Table 4: Legend of connection schemes eTronic 7000

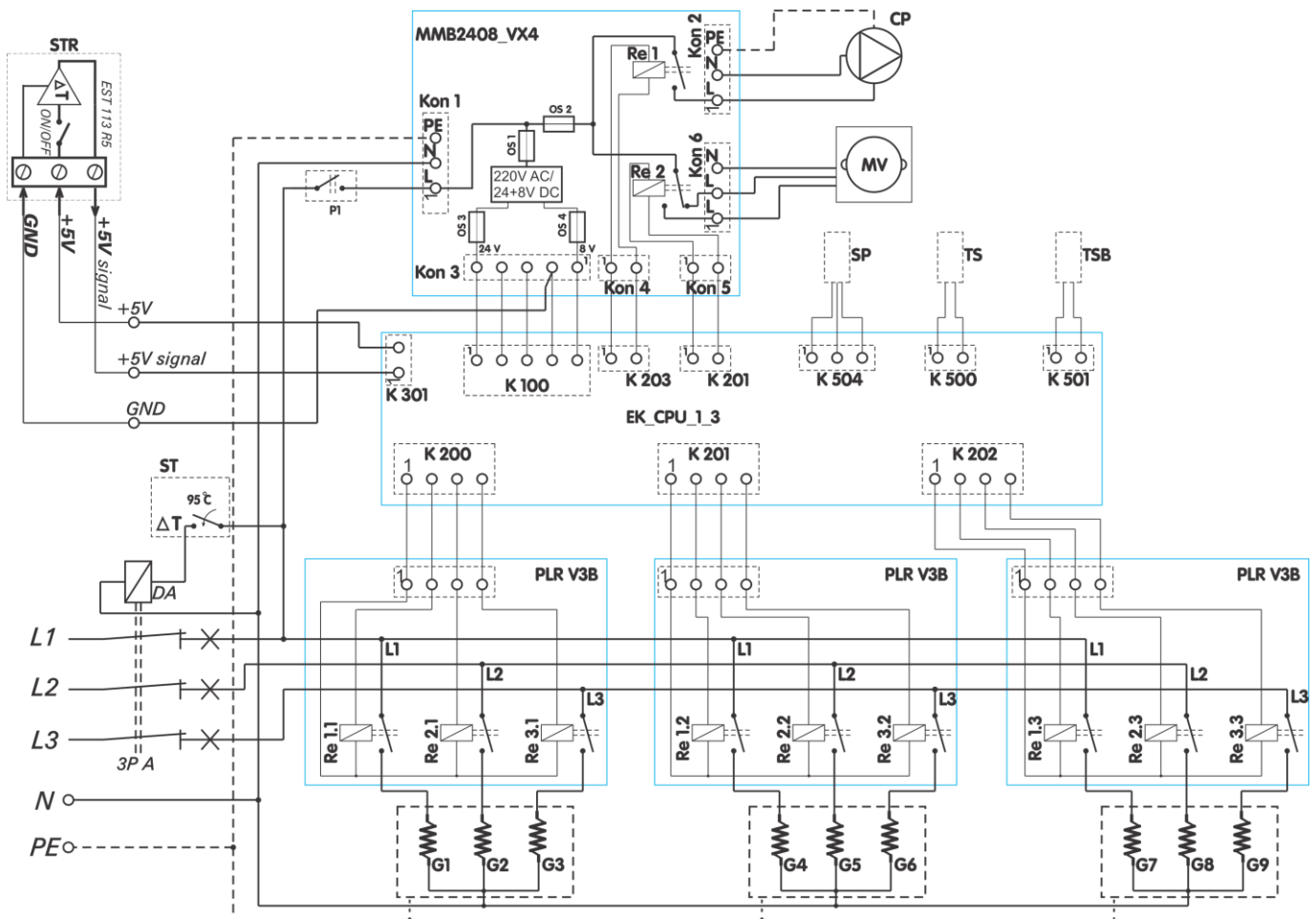
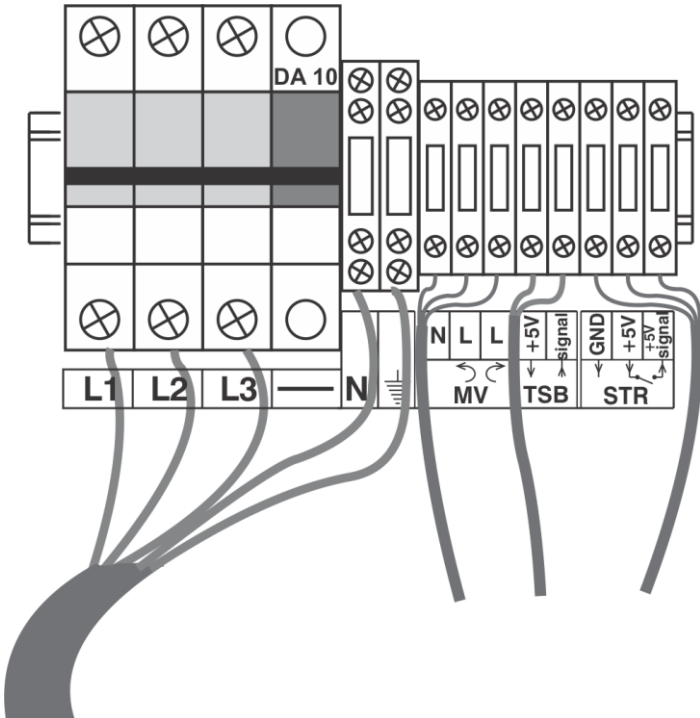
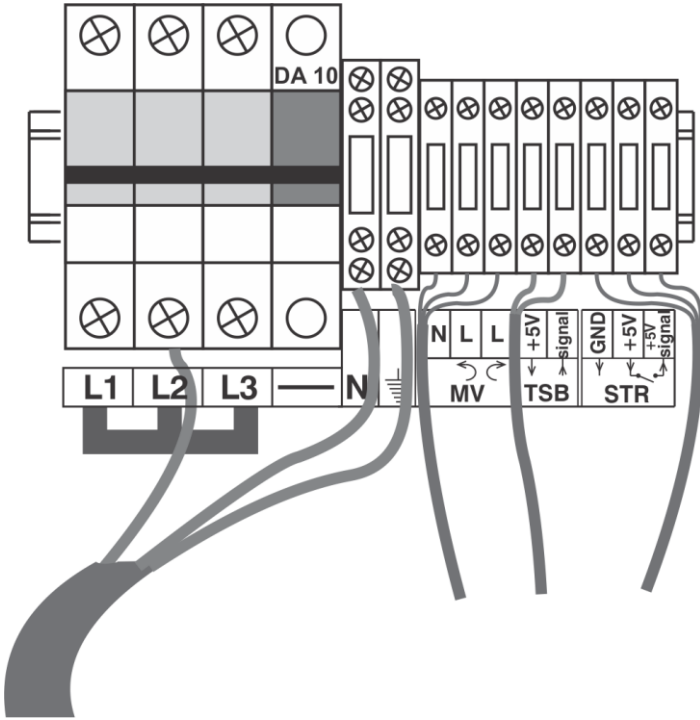

Image 8: Management scheme for eTronic 7000

5.4 Power cable connection scheme

Image of power cable connection scheme.

- Scheme of connection of the clamps and connection of the boiler to a **single phase power supply**
- Only for models:
- eTronic 7000 6kW
- eTronic 7000 9kW



Scheme of the connecting clamp and connection of the device to three-phase power supply

5.5 Connect the external control of the boiler (room thermostat)

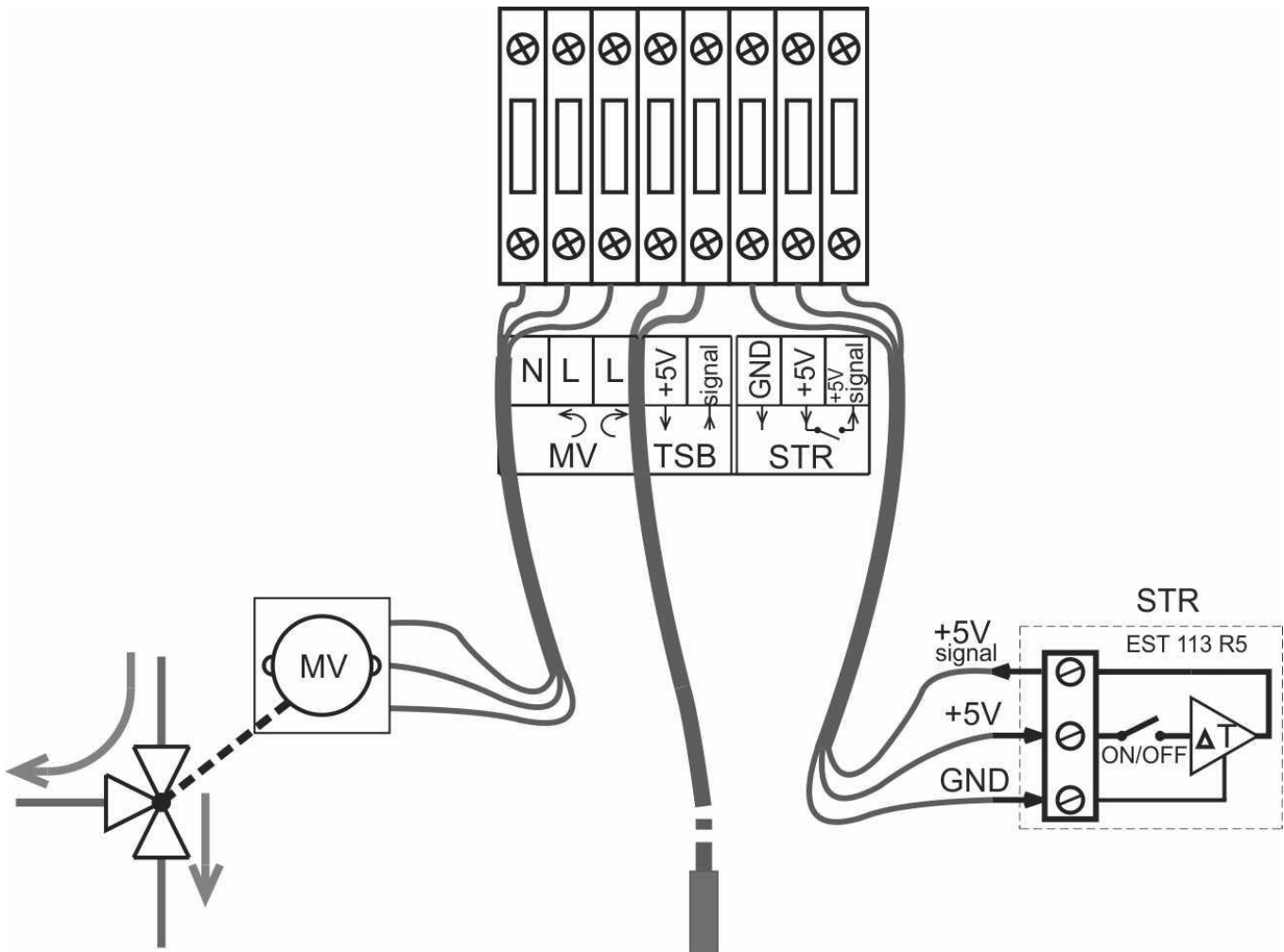

Scheme of connection of room thermostat, probe for measuring the temperature in the boiler and control of the motor three-way valve (**230V 50Hz**).

Note: As shown in the scheme, the room thermostat MIKOTERM EST 113 R5 is connected, and if another thermostat is used, the clamp with the GND marking is not connected.

WARNING: Use a room thermostat with zero-voltage contacts.

The management of the preparation of sanitary water is an option.

6. Putting into operation

After completing the works described below, complete the report on the putting into operation (chapter 6.3).

6.1 Before putting into operation



NOTE: Material damages caused by unprofessional handling!

Putting into operation without sufficient amount of water destroys the device.

- ▶ Always switch on the boiler and use it only if it has enough water.



The boiler must work with a minimum pressure of 0.8 bar.

Prior to putting into operation, check that the following elements and connections are properly connected and function correctly:

- Impermeability of the heating installation,
- all pipes and armature,
- all electrical connectors.

6.2 First putting into operation



NOTE: Material damages caused by improper handling!

- ▶ Inform the client/user of the device about handling with it.

- ▶ Before first putting into operation, check that the heating installation is filled with water and air-discharged.
- ▶ Turn on the main switch (on the bottom side of the device)
- ▶ All parameters of the heating system and the device itself will appear on the display
- ▶ The device is factory set to operate in the heating mode (preparation of sanitary water is switched off). Set values: temperature of 10°C and power of 0 kW.
- ▶ Only the value of pressure in the installation will be the one you set on the display when filling the installation with water.

6.3 Record on putting into operation

Putting into operation		Measures/values	Notes
1.	Boiler type		
2.	Serial number		
3.	Set thermostat regulation	<input type="checkbox"/>	
4.	Fill and discharge the air from the heating installation and check the impermeability of all connectors	<input type="checkbox"/>	
5.	Establishing operating pressure	<input type="checkbox"/> _____ bar	
	Check the pressure of the expansion container	<input type="checkbox"/> _____ bar	
6.	Test safety devices	<input type="checkbox"/>	
7.	Set the electric connection according to local regulations	<input type="checkbox"/>	
8.	Check of the functions of the device	<input type="checkbox"/>	
9.	Users informed, technical documentation submitted	<input type="checkbox"/>	
10.	Confirmation of professional putting into operation	Seal of service technician / signature / date	

Table 5: Record on putting into operation

7. Handling the heating installation

7.1 Instructions for operation

Safety instructions

- ▶ Ensure that the boiler is operated only by adults familiar with the instructions and operation of the boiler.
 - ▶ Make sure that children are not kept unattended in the area of the boiler.
 - ▶ Do not leave or store easily flammable objects within a safety distance of 400 mm around the boiler.
 - ▶ Flammable objects must not be placed on the boiler.
 - ▶ The user must comply with the operating instructions.
 - ▶ The user may only switch on the boiler (except for the first putting into operation), set the temperature on the control unit and put the boiler out of the drive. All other works must be carried out by an authorized service technician.
 - ▶ The authorized person who carried out the installation is obliged to inform the user about the handling and the correct, safe operation of the boiler.
 - ▶ The boiler must not work in case of danger of explosion, fire, emission of gases or steam.
 - ▶ Beware of the flammability properties of the components (→ instructions for installation and maintenance).
-

7.2 Overview of handling elements

7.2.1 Functions of the device

We will briefly introduce you to the most important characteristics of the boiler eTronic 7000

- Electric boiler eTronic 7000 contains all elements of boiler substations ie. small boiler rooms.
- Unlike previously known models, this model has many advanced functions that not only make it easier to work with the device, but also provide a longer life and safer operation of the device.
- The temperature sensors and sensors of the hydraulic pressure of the water in the installation monitor changes in the system and send information to the processor that processes them and controls the boiler based on them.
- Communication of users and service technicians (installers) with the device is facilitated and improved through a display showing all the essential parameters of the device and the system itself.
- The setup is facilitated and performed by four buttons located just below the display.

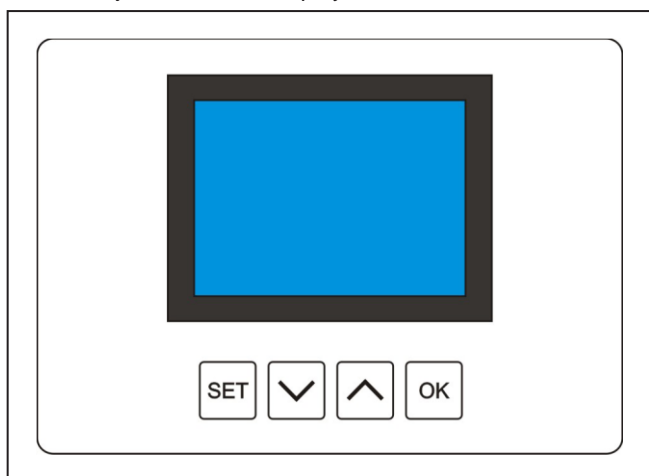

Image 9: Display and push-buttons

7.2.2 Basic settings

- It is necessary to set the operating pressure to 1.2 bar (+ 0.4) for normal operation of the device when filling and discharging air from the heating system.
- If the operating pressure is less than 0.8 bar, a warning will appear on the display (see table 3 Warning signs) and if the operating pressure continues to fall and drop below 0.4 bar, the boiler will be switched off with the error information on the display.
- If the operating pressure is greater than 2.2 bar, a warning will appear on the display, and if it exceeds 2.6 bar, the boiler will be switched off with the error information on the display.



ATTENTION! If the operating pressure continues to increase, the mechanical safety valve will open at 3 bar and release the part of the water from the boiler, until the pressure drops to the allowed value.

- The circulation pump is high efficiency **Wilo-Para MSL/6-43/SC** (→ see more in chapter 11).

The boiler can work in four (4) regimes.

- 1 Heating,
- 2 Preparation of sanitary water,
- 3 Heating and sanitary water,
- 4 Freezing protection regime.

7.2.3 Heating regime

- Depending on the power of the boiler, the power can be adjusted in steps

Pwer of the boiler	steps (kW)
6 kW	2+2+2
9kW	1,5+1,5+1,5+1,5+1,5+1,5
12kW	2+2+2+2+2+2
18kW	2+2+2+2+2+2+2+2
24kW	2,7+2,7+2,7+2,7+2,7+2,7+2,7+2,7+2,7

Table 6: Power and steps of adjusting the power

The processor takes care of:

- Even load of phases no matter of the power on which is set the boiler.
- Even load of output relays and heaters.
- If necessary, the relays and heaters that have been switched on for a long time are switched off, and relays and heaters that were inactive switch on instead.
- In this way, the electrical network is symmetrically loaded, and all elements of the boiler work equally, thus achieving a longer lifetime of exploitation of the device.

Operating temperature

- Is set in steps of/from 1 °C
- The operating temperature range ranges from 10 °C to 80°C

Switching on and off the heaters

- is carried out periodically with a 3-second intervals with division of power in three (3) groups which are temperaturely shifted by 3 °C.

The overview of switching on and off is given in image 10.

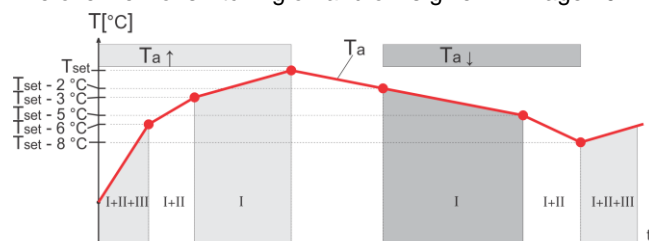

Image 10: Switching on and off the heaters

Tset – SET value of temperature;

Ta – Current temperature;

Ta↑ – the temperature rises;

Ta↓ – the temperature drops;

I – heating group no. 1

II – heating group no. 2

III – heating group no. 3

Circulation pump Wilo-Para MSL/6-43/SC

- Is switched on on the command of the room thermostat.
- The room thermostat also switches off the heaters and the pump when it reads the temperature which is set in the room.



If the room thermostat does not switch on the pump for some reason, the heaters will not switch on as well. The error message will appear on the display.

- If the boiler has reached the set water temperature in the system, the heaters will be switched off and the pump will continue to work for an additional 2 minutes.

Freezing protection regime:

- Pump is always switched on.
- The power of the boiler is 1/3 of the nominal power and cannot be changed.
- Operating temperature is fixed to 10°C and cannot be changed.
- Room thermostat has no effect on boiler operation.

7.2.4 Symbols that may appear on display



Image 11 and 12: symbols on the display

- 1 Time
- 2 Date
- 3 Symbol of radiator (temperature of the system) or symbol of the boiler
- 4 Current temperature of the system (possible display from -99 to 99 °C)
- 5 The set temperature of the system (possible display from 10 to 80 °C)

- 6 Symbol of measuring unit of temperature (°C)
- 7 The symbol of the container under pressure
- 8 Pressure in the system (possible display from 0 to 3.6 bar with one decimal)
- 9 Symbol of measuring unit of pressure(bar)
- 10 Symbol of electricity
- 11 Current power of the boiler in kW (display with one decimal)
- 12 The set power of the boiler in kW (displayed with one decimal)
- 13 Symbol of measuring unit of electricity (kW)
- 15 Symbol of the circulation pump (appears only when the pump is switched on)
- 16 Symbol of space that is heated (house)
- 17 Symbol of switched on room thermostat
- 18 Warning symbols (A0-A4) or error symbols (E0-E8)
- 19 Symbol of danger (appears when the value of pressure or temperature exceeds the permitted limits)

7.2.5 Warning symbols (codes)

- A1- warning: Approaching the lower limit of the allowed operating pressure (0.8 bar).
 A2- warning: Approaching the upper limit of the allowed pressure (2.2 bar).
 A3- warning: Approaching the lower limit of the allowed temperature (5°C).
 A4- warning: Approaching the upper limit of the allowed temperature (80°C).

7.2.6 Error symbols (codes)

- E0- error: The set parameters are not within the limits (this situation is practically impossible if the eeprom is not empty and the boiler is switched on for the first time).
 E1- error: Pressure value below the lower limit (0.4 bar) ALL SWITCHED OFF.
 E2- error: Pressure value above the upper limit (2.6 bar) ALL SWITCHED OFF.
 E3- error: Temperature value of the boiler equal or below the lower limit (3°C) ALL SWITCHED OFF.
 E4- error: Temperature value of the boiler equal or above the upper limit (85°C) ALL SWITCHED OFF.
 E5- error: Temperature value of the boiler equal or below the lower limit (3°C) INFORMATIVE.
 E6- error: Temperature sensor of the boiler in break or in short circuit ALL SWITCHED OFF.
 E7- error: Temperature sensor of the boiler in break or in short circuit ALL SWITCHED OFF.
 E8- error: Sensor of the pressure in break or in short circuit ALL SWITCHED OFF.

7.3 Heating regulation

Setting heating parameters

Based on the display on the screen (Image 13), there can be read:

- 1 Time
- 2 Date
- 4 Current temperature of the system
- 5 The set temperature of the system
- 8 Operating pressure in the system
- 11 Current power
- 12 The set power of the boiler
- 15 Information on operation of the pump
-if the pump symbol is on the screen the PUMP is SWITCHED ON AND WORKS
- 17 Information on the status of the room thermostat
-if the symbol is on the screen the ROOM THERMOSTAT IS SWITCHED ON

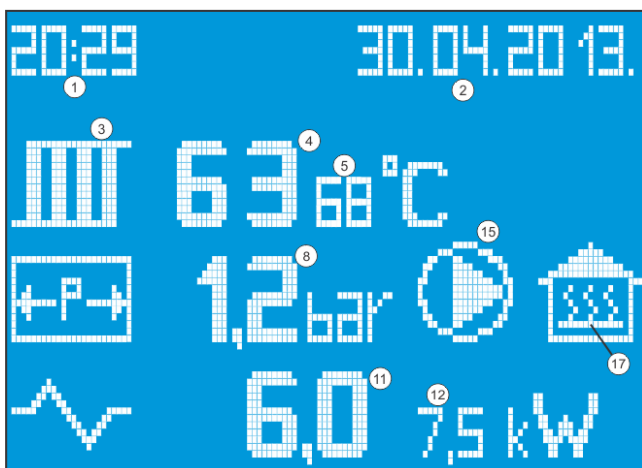



Image 13

Setting operating temperature of the boiler

-By pressing the SET button you enter the mode for setting parameters. The set operating temperature of the boiler is flashing, which can now be increased or decreased with the buttons  and . Each press on the button increases or decreases the operating temperature of the boiler by one °C.

The change must be confirmed by pressing the SET button. If the change is not confirmed, after 15 seconds from pressing any button (except SET), the controller continues to operate according to the old value of the set temperature and exits the setting mode.

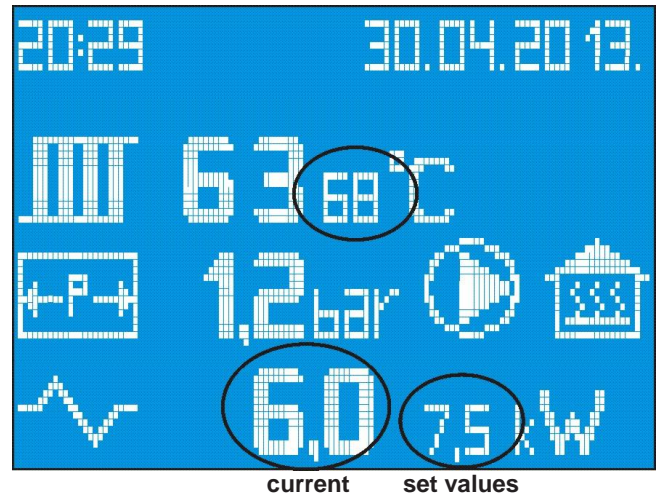



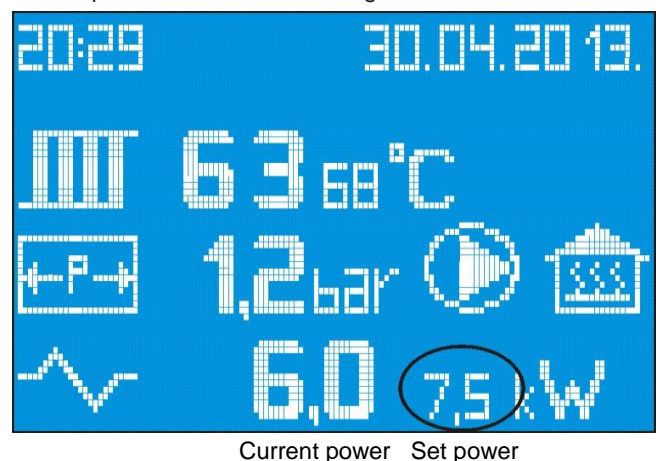

Image 14: Setting the operating temperature of the boiler

Setting the power of the boiler

- If a change is confirmed after the temperature is set (press OK), the controller switches to power adjustment. If we do not want to change the temperature, but only the power, when the value of the set temperature begins to flash, press the OK button and switch to the power setting of the boiler. The set value of power of the boiler starts to flash, and it is now possible to increase or decrease it by using the buttons  .

Each use of the button  increases the power of the Boiler by 1,5kW, and every use of the button  reduces the power of the boiler by 1,5kW. So, it is possible to set one of the following values of power of the boiler: 1,5kW;3kW; 4,5kW;6kW;7,5kW;9kW (FOR BOILER OF 9kW POWER). The change must be confirmed by pressing the SET button. If the change is not confirmed, after 15 seconds from pressing any button (except SET), the controller continues to operate according to the old value of the set power and exits the setting mode.



Current power Set power

Image 15: Setting the power of the boiler

Setting time and date

In the setting mode of the boiler's operating mode, that is, by selecting a function by pressing the OK button you can go through all the elements that can be set. When we get to the time and date, first the hours will start to flash, then the minutes and then the year, the month and the day. Setting is done by using the buttons ▼▲.

Change of parameters is confirmed by pressing the SET button.

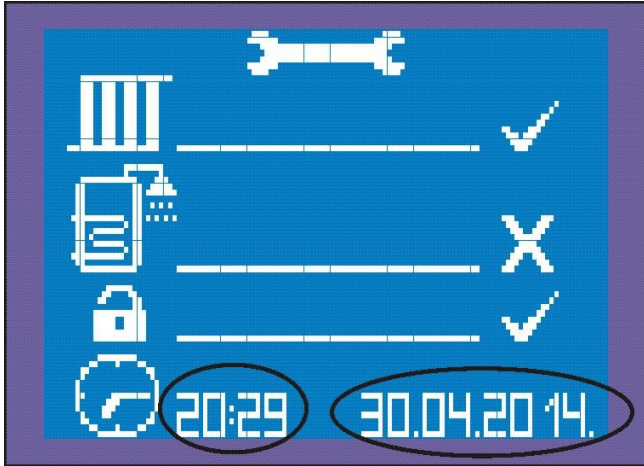

Image 16: Setting time and date

If the change is confirmed after setting time and date, the controller switches to setting the operating regime, that is, selection of normal operating regime or the regime of freezing protection system.

Selection of the operating regime of the boiler

It is carried out by setting the functions of the boiler

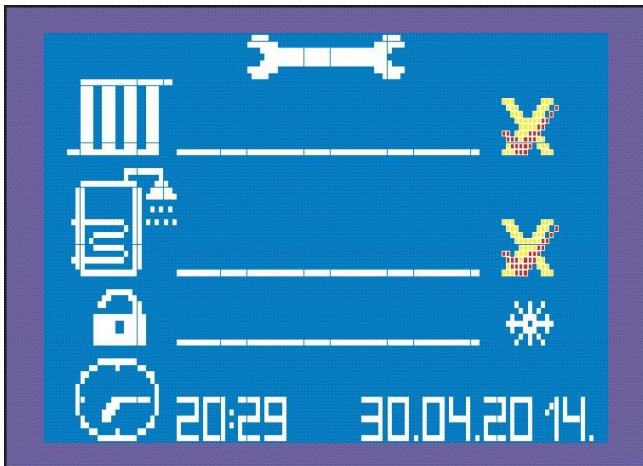



Image 17: Position of symbols for selection of operating regime of the boiler (heating regime)

1) This operating regime of the boiler is confirmed by pressing the SET button. Operating regime of heating is described in item 7.2.3.

- And exits the setting mode.

2) If the following button  is pressed, instead of the snowflake, there appear the symbol checked or the bin which flash on the display and show the operating regime. Selected regime is confirmed by pressing the SET button.

- Freezing protection regime is described in item 7.2.3 (→ see image 18).

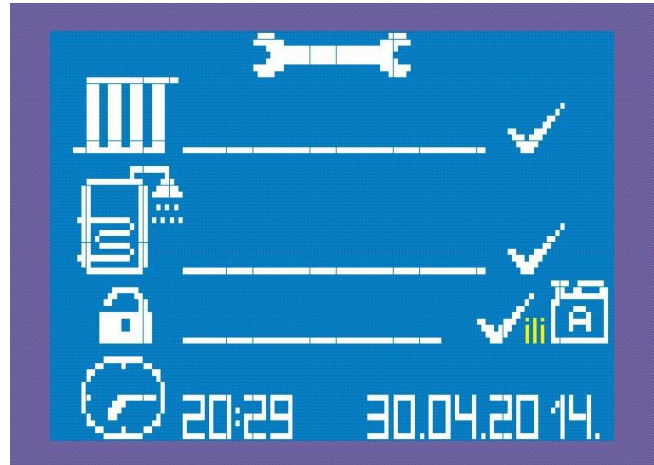

Image 18: Position of symbols for selection of operating regime of the boiler

By pressing the OK button, this mode is activated in which the fixed temperature is maintained at 10 °C and the fixed power of the boiler (1/3 of the minimum power)

The pump is always switched on in this regime and the room thermostat has no effect on the operation of the boiler.

If the change of operation regime is not confirmed by pressing OK button, after 15 seconds from pressing any button (except OK), the controller continues to operate in normal heating regime.

Warnings on the display (pressure and temperature)

Warnings related to operating pressure

- When the operating pressure in the system is less than 0.8 bar or greater than 2.2 bar, the current value of pressure starts to flash.

- A warning triangle, which flashes all the time, appears in the upper right side of the display below the date (image 19).

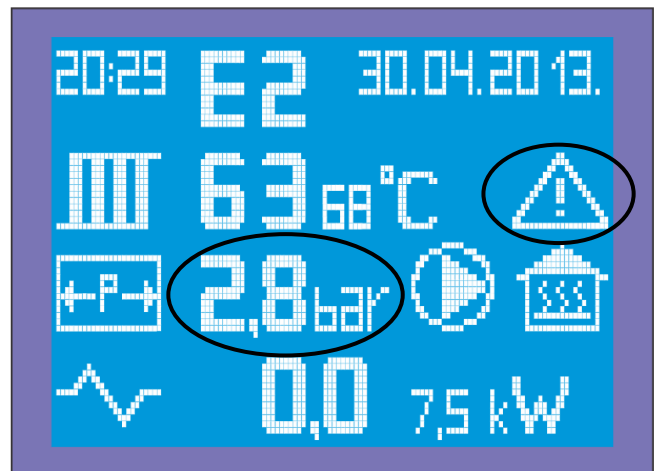

Image 19: Warnings related to operating pressure

- A1 for operating pressure below 0.8 bar
- A2 for operating pressure above 2.2 bar

The boiler still works normally. If the pressure drops below 0.5 bar or increases above 2.5 bar the heaters switch off, and the warning code shifts to error code.

- E1 for operating pressure below 0.5 bar
- E2 for operating pressure above 2.5 bar.

In order to keep the boiler working, it is necessary to bring pressure within the normal value limits. Image 19.

Warnings related to temperature

- When the temperature in the system is less than 5°C or higher than 80°C, the current value of temperature starts to flash, and a warning triangle is displayed that continuously flashes as well as warning codes (Image 20)

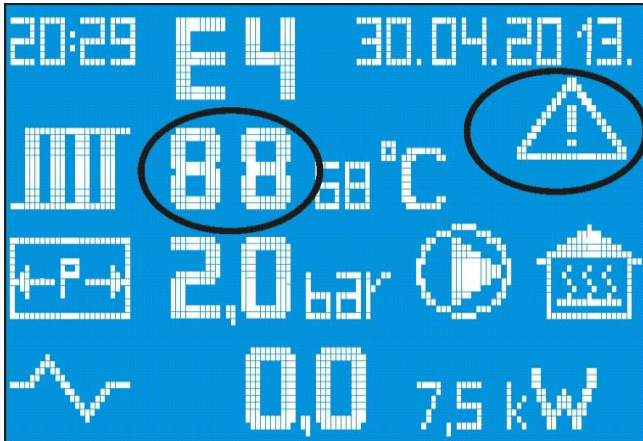

Image 20: Warnings related to temperature

- A3 for temperature below 5°C
- A4 for temperature above 80°C

If the temperature drops below 3°C, the heaters and the pump switch off, and the warning code shifts into the error code:

- E3 for temperature below 3°C

The heaters will switch off if the temperature rises above 85°C, and the pump works regardless of the room thermostat, and the warning code shifts to error code:

- E4 for temperature above 85°C

To keep the boiler working, the condition is that the temperature returns to normal values.

7.3.1 Regulator of room temperature

If the regulator of room temperature is used, it must be installed in the reference room. Control of the temperature of all rooms by the heating system is carried out by this remote control. Radiators in the reference room should not be equipped with thermostatic valves, or they must always be open. All radiators in other rooms can be equipped with thermostatic valves.

7.3.2 Cease of heating

The temperature of the boiler must be lowered in the short-term cease of heating by using boiler's thermostatic regulator. To prevent the freezing of the heating installation, the temperature of the boiler must not be set below 5°C. The boiler must be put out of operation in case of longer cease of heating (→ chapter 7.4).

7.4 Putting the boiler out of operation



WARNING: Material damages caused by freezing!

If the heating installation is out of operation, it could freeze at low temperatures.

- ▶ Protect the heating installation from freezing.
- ▶ Empty the installation if there is a risk of freezing and if the boiler is out of operation.



When the device is put out of operation for a long time, the pump of heating can be blocked. To remove the blockage, it is necessary to act as in the case of discharging of air (→ chapter 4.6.2).

- ▶ Place the main switch on the control panel in position "0" (switched off).
- ▶ Protect the heating installation from freezing. Empty all lines completely.

Operating principle of eTronic 7000

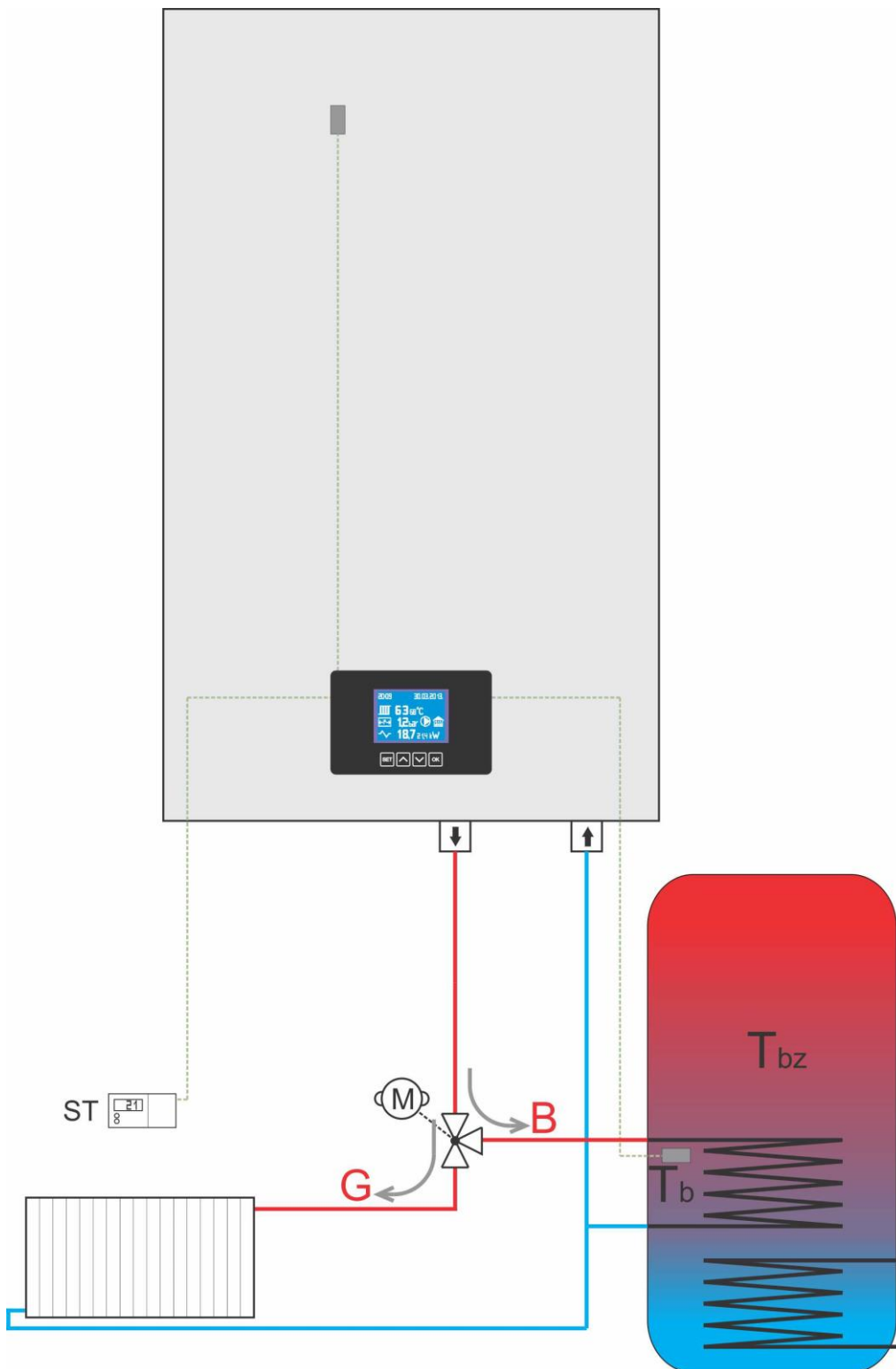

Overview of the use of the electric boiler eTronic 7000 in systems of heating and preparation of sanitary water

NOTE: Perform setting and selecting of the regime in which the boiler will operate only when the room thermostat does not require heating and when the basic elements of the boiler, such as pump and heaters, are not included.

7.5 Sanitary water preparation regime

The eTronic 7000 device has the option of controlling a three-way motor valve in order to enable the heating of sanitary water in the boiler with a heat exchanger.

7.5.1 Setting desired regimes

In order to select the desired operating regime of the device, press and hold the SET button for more than 3 seconds. Then an overview will appear on the display as in Image 21.

- A) Symbol of heating regime
- B) Symbol of sanitary water preparation regime
- C) Selection of security mode at low temperatures
- D) Symbol of clock for setting time and date

Desired regime is chosen by simply selecting the symbol and its setting (X) SWITCHED OFF (✓) SWITCHED ON. Symbols are changed by pressing the ▲▼ buttons.

1. Setting HEATING (ON) – SANITARY WATER (OFF) - Safety STANDARD

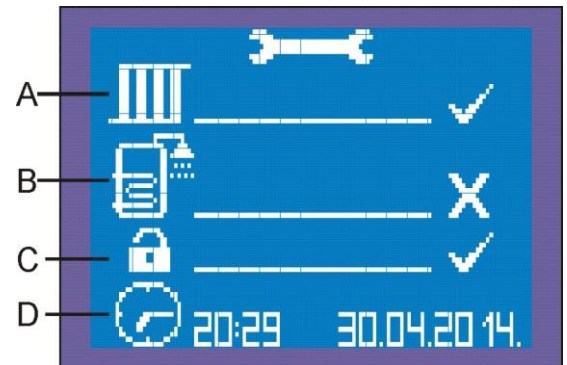

Image 21 (above)

2. ALL SWITCHED ON. Regimes of heating and preparation of sanitary water are switched on
Safety: standard setting.

The boiler will operate normally when the room thermostat requires room heating.

When the room thermostat switches off the boiler, that is, when the room is warmed, processor reads temperature in the boiler and if it is lower than the set one it gives the command to the boiler to heat the sanitary water by the three-way motor valve which is run by the boiler.

STANDARD Safety – which means that the device is not set to anti-freezing mode and that there is ordinary water in the system and not the thermofluid.

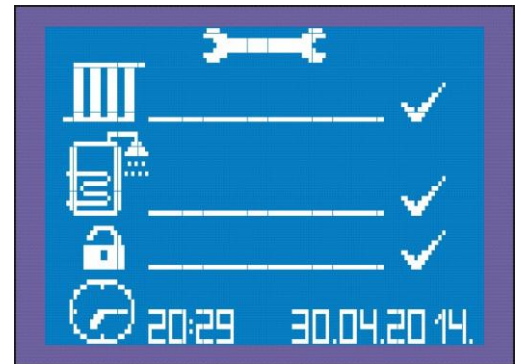

Image 22 (above)

Setting HEATING (ON) – SANITARY WATER (ON) Safety STANDARD

NOTE: Perform setting and selecting of the regime in which the boiler will operate only when the room thermostat does not require heating and when the basic elements of the boiler, such as pump and heaters, are not included.

3. Heating SWITCHED OFF, preparation of sanitary water SWITCHED ON. Safety STANDARD.

The device is only allowed to operate the regime of heating the sanitary water in this regime. The device will control the temperature in the boiler and will switch on the heaters and the pump if necessary. The room thermostat has no effect on the operation of the boiler in this setting.

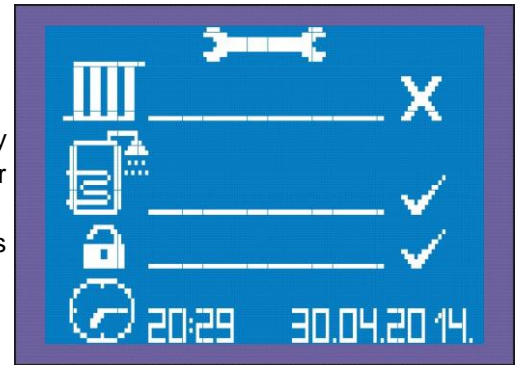

image 23 (above)

Setting HEATING (OFF) – SANITARY WATER (ON) - Safety STANDARD

4. Heating and preparation of sanitary water SWITCHED OFF Safety STANDARD

The boiler will not work either on heating or on the preparation of sanitary water in this regime.

Both the room thermostat and the probe for measuring temperature in the boiler have no effect on the boiler.

Safety at a standard level means that if temperature in the system drops below 3°C the boiler will not switch on for safety reasons until the temperature in the system exceeds 3°C.

There is a risk of freezing of the installation in this setting.

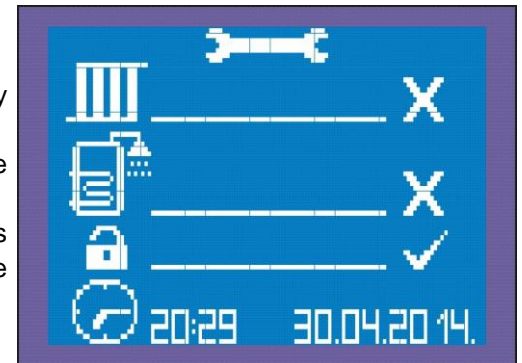

image 24 (above)

Setting HEATING (OFF) – SANITARY WATER (OFF) - Safety STANDARD

5. Heating and Sanitary water SWITCHED ON OR SWITCHED OFF Safety BIN

The boiler works normally and controls the set regimes, regardless of which of the two regimes are in function or both. The heating regime always has advantage

Safety BIN means that the system is filled with the mixture of water and thermofluids.

In this setting, if the temperature in the system drops below 3°C, the device will work normally when it is required of it.

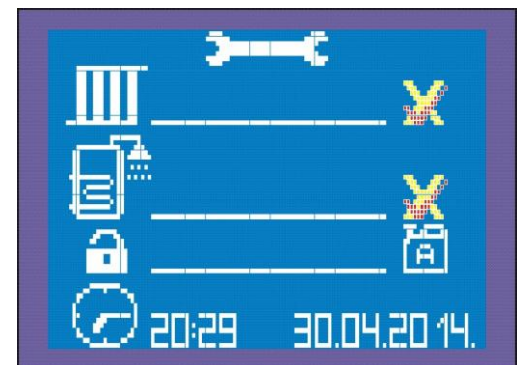

Setting HEATING (ON/OFF) – SANITARY WATER (ON/OFF) - Safety THERMOFLUID in the system

image 25

6. Heating and sanitary water SWITCHED OFF OR SWITCHED ON Safety SNOWFLAKE

Anti-freezing regime. The boiler works according to factory-set parameters (see the description of anti-freezing regime).

The device protects itself and the heating system against low temperatures.

This mode is also called WINTER HOLIDAY MODE.

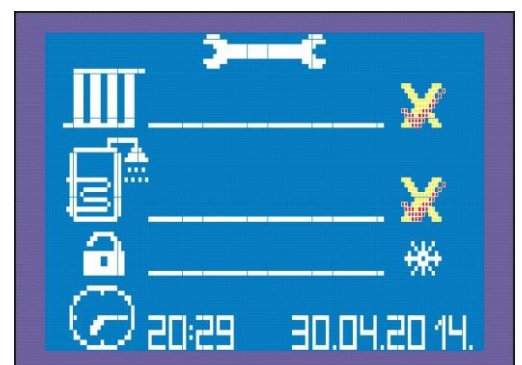

Setting HEATING (ON/OFF) – SANITARY WATER (ON/OFF) - Safety ANTI-FREEZING

image 26

NOTE: Perform setting and selecting of the regime in which the boiler will operate only when the room thermostat does not require heating and when the basic elements of the boiler, such as pump and heaters, are not included.

Description of the SAFETY regime

Checked everything works according to the rules given for the specific mode defined by the combination of the selected symbols in the first two items of the menu. The program protects the heating system from low temperatures by not allowing the operation of the boiler on temperature of 3°C or below (which is measured by the sensor in the boiler) because there is a risk that the installation is frozen.

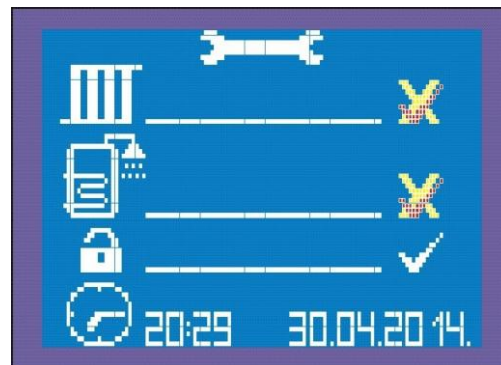

image 27

Bin a system filled with a mixture of antifreeze and thus protected from freezing. Everything works according to the rules given for the specific operating regime which is defined by the combination of selected symbols in the first two items of the menu, but a part of the program that blocks the operation of the boiler at a temperature of 3 °C or lower is switched off. In other words, operation of the boiler is allowed regardless of the possible low temperatures in the boiler. Also, there is no need to warn about approaching to the lower limit of the allowed temperature, as well as about the low temperature errors.

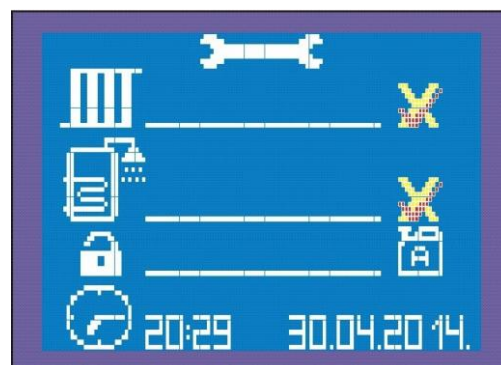

image 28

Snowflake activated freezing protection regime. This regime is designed to protect against freezing of the system in a shorter period (10 days), e.g. during winter, when there is no need for heating in the house (apartment), but due to low outdoor temperatures. There is a possibility that the system freezes if the heating is switched off and the system is not filled with antifreeze. The pump operates non-stop in this regime, maintaining the temperature of the system from 7-10°C by using 1/3 of the nominal power. The relay of the boiler is switched off for 20 minutes and switched on again for 10 minutes to protect the heat exchanger in the boiler. When this regime is selected, the first two items of the menu are automatically de-checked, and no setting can be made until the safety mode changes and one of the other two signs (operating regimes) is selected instead of the snowflake.

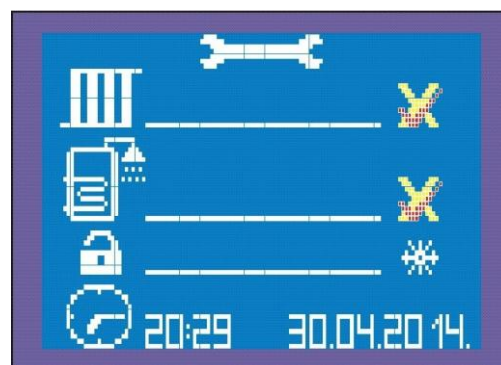

image 29

Operating regime

HEATING SWITCHED ON + SANITARY WATER SWITCHED ON SAFETY CHECKED or BIN

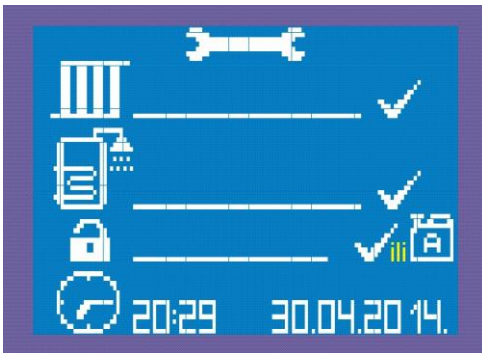

image 30

- heating has priority, when the room thermostat switches off the sensor of temperature is in charge in the boiler and if the temperature of the boiler is lower than the set one, which is reduced by 3°C, the relay of the boiler is switched on (the motor valve is switched, which directs the water from the boiler to the heat exchanger in the boiler), 'b' appears on the display, and if necessary, relays of the heater switch on or off depending on the temperature.
- when symbol √ is in the safety mode, operation of the boiler is blocked on the temperature of 3°C or lower.
- when symbol of bin is in the safety mode (antifreeze mode), there is no blockade of operation of the boiler regardless of the possible low temperature of the boiler. Everything else is the same in both cases.

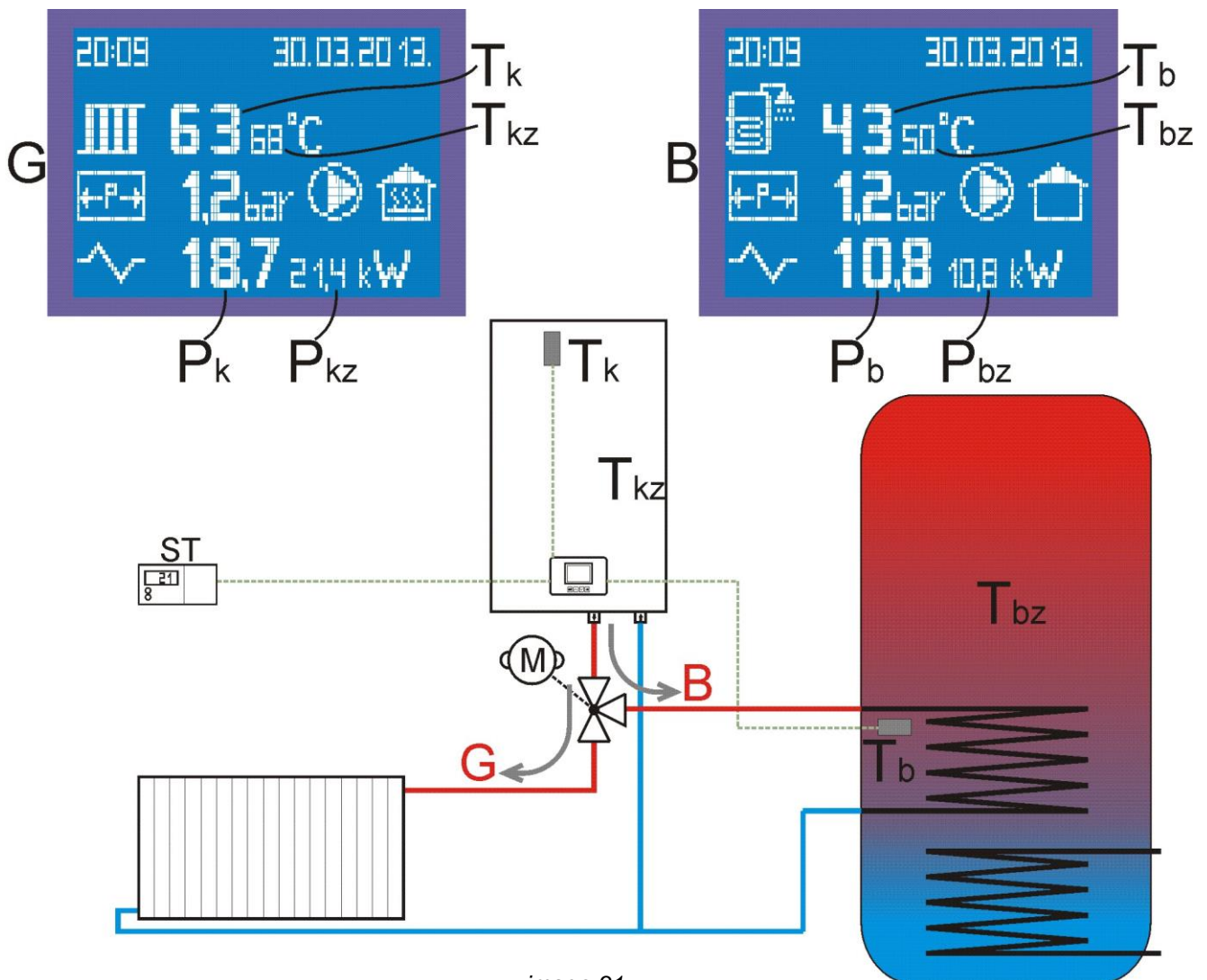

image 31

HEATING REGIME

Tkz - The set temperature of the boiler to which the water should be heated in the heating regime

Tk - Current temperature of the boiler in any regime

SANITARY WATER PREPARATION REGIME – BOILER REGIME

Tbz - The set temperature of the boiler to which the water in it should be warmed.

In this regime, the temperature of the boiler to which it needs to heat is calculated as: $Tkz = Tbz + 15^{\circ}\text{C}$

Tb - Current temperature of the boiler. PUMP WORKS UNTIL $Tb = Tbz$

HEATING REGIME

Tkz - The set temperature of the boiler to be heated in the heating regime

Tk - Current temperature of the boiler in any regime

SANITARY WATER PREPARATION REGIME – BOILER REGIME

Tbz - The set temperature of the boiler to which the water in it should be warmed.

In this regime, the temperature of the boiler to which it needs to heat is calculated as: $Tkz = Tbz + 15^{\circ}\text{C}$

Tb - Current temperature of the boiler in any regime

The boiler must reach the Tkz temperature which is calculated according to the above-mentioned formulas and, if necessary, switch the heaters on or off according to the rules which are already defined. The pump works in this regime until the current boiler temperature (Tb) reaches the set temperature of the boiler (Tbz).

Check of the set parameters of Heating and Sanitary water preparation



image 32

The overview of the display changes, by pressing the OK button, in order to check parameters which are set in the sanitary water regime



image 33

Overview of the HEATING regime is presented by **the RADIATOR symbol**



image 34

The set and current parameters of the heating system can be checked by pressing the OK button, if the device is in the sanitary water regime



image 35

Overview in the HEATING regime is presented by **the BOILER symbol**



The changed overview remains on the display for 15 seconds and after that time it returns to the basic overview. Another way to change the overview is to press the OK button.

THE SETTING MODE IS ENTERED BY SHORT PRESSING OF THE 'SET' BUTTON IN ANY REGIME:

The display shows **'G'**, the set temperature of heating starts to flash and it can be set in the range of 10 - 80°C. When it is set - by pressing **'OK'**, it switches to the setting of the following parameter: the set power of heating flashes - after the setting (if preparation of sanitary water is not activated), if the **'OK'** button is pressed, the set heating temperature flashes and thus in circle. To remember the changes that are made, that is, the new set values and to exit from the setting, the **'SET'** button must be pressed. If the **'SET'** button is not pressed within 15 seconds from the last pressing of some of the other buttons, the processor exits the setting mode and continues to work according to the "old" set values of power and temperature.

The setting is continued after setting the temperature and the power of the heating, if the preparation of sanitary water is activated as well:

- now, instead of the symbol of radiator, the symbol of boiler appears (overview **'B'**). The presented current temperature is the temperature of the boiler, and the set temperature of the boiler that can be set in the range of 10 - 70°C starts to flash and it is taken (increased by 15°C max. 80°C) as the temperature to which the boiler is heated while in the sanitary water preparation regime. If the **'OK'** button is pressed after setting this temperature, the set power of the boiler for the preparation of the sanitary water begins to flash, and it should be set taking into account the volume of the boiler, the power of the heat exchanger and the nominal power of the boiler, that is, choose the optimum power for preparation of hot water in the boiler. To remember the changes that are made, that is, the new set values and to exit from the setting, the **'SET'** button must be pressed. If the **'SET'** button is not pressed within 15 seconds from the last pressing of some of the other buttons, the processor exits the setting mode and continues to work according to the "old" set values of power and temperature.

Function of the timer in sanitary water preparation regime

A timer appears on the display next to the symbol of boiler in the setting mode when the function of sanitary water preparation is enabled. Format of the timer is **00:00 - 00:00** (24h marking time).

It appears only when the function is CHECKED.

The device comes as factory-set at **00:00 - 00:00** which means that the timer allows the preparation of sanitary water throughout the day. If two times are set, for example: **22:50 - 22:50**, the preparation of sanitary water is still possible throughout the day.

This function is introduced in order to connect the boiler to another heating system, for example: solar or to solid fuel boiler. It is good then to set up the preparation of sanitary water in a certain period of time when there is no sun or when the solid fuel boiler is not charged.

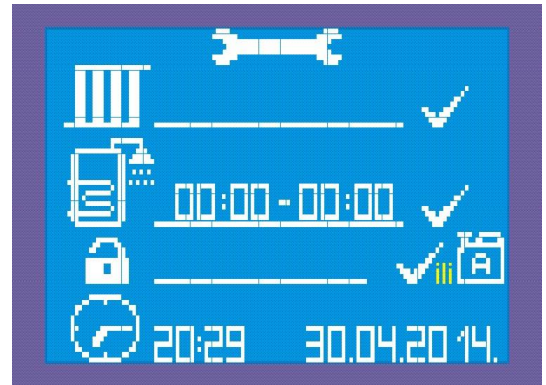

image 35

The image shows an example of setting the function of the preparation of sanitary water for a period of time from 20:00 to 04:00. There is no energy of the sun in this period, so it is necessary to prepare sanitary water for use in the evening or in the morning hours.

This setting also allows the preparation of sanitary water in hours of less expensive electricity.

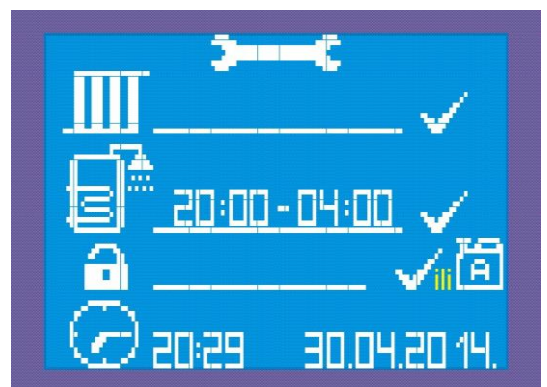

image 36

Setting

When the sanitary water preparation regime is enabled, a timer appears on the display. We go through the setting parameters by pressing the OK button. Time will start to flash in the following order:

00:00 - 00:00 – hours of switching on are set (for example 20)

20:00 - 00:00 - minutes of switching on are set (for example 30)

20:30 - 00:00 - hours of switching off are set (for example 04)

20:30 - 04:00 - minutes of switching off are set (for example 30)

Means that we set the time to **20:30 - 04:30**

Every setting in any regime is confirmed by pressing the SET button.

Modulation of the engaged power for models: 6, 9 and 12kW

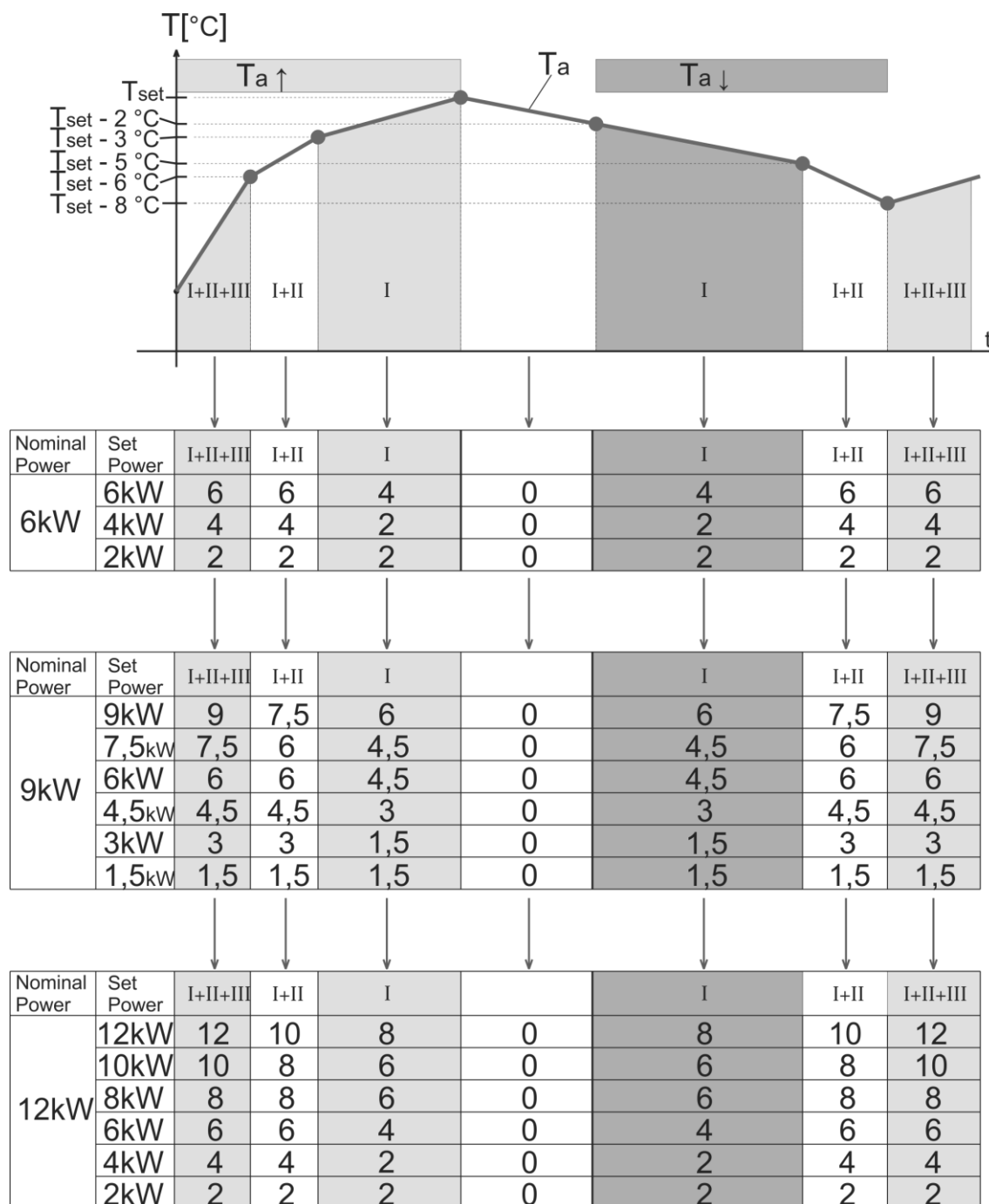

T_{set} – SET value of temperature; T_a – Current temperature; $T_a \uparrow$ - the temperature rises; $T_a \downarrow$ - the temperature drops;

I+II+III – All heating groups is turned on, engaged power is equal to set power;

I+II – Power modulation started, engaged power is reduced, 3. heating group is turned off;

I – Power modulation continue, engaged power is additionally reduced, only 1. heating group is turned on;

Note:

when the set power can not be divided into 3 groups, it is divided into 2 groups, (for example, with a boiler with a nominal power of 6kW and set 4kW, it can only be divided as 2 + 2kW) or, if this is not possible as well, then the complete set power switched on and off in one degree (for example, with a boiler of nominal power 6kW and set 2kW - it can not be divided into 2 or 3 groups).

Modulation of the engaged power for models: 18 and 24kW

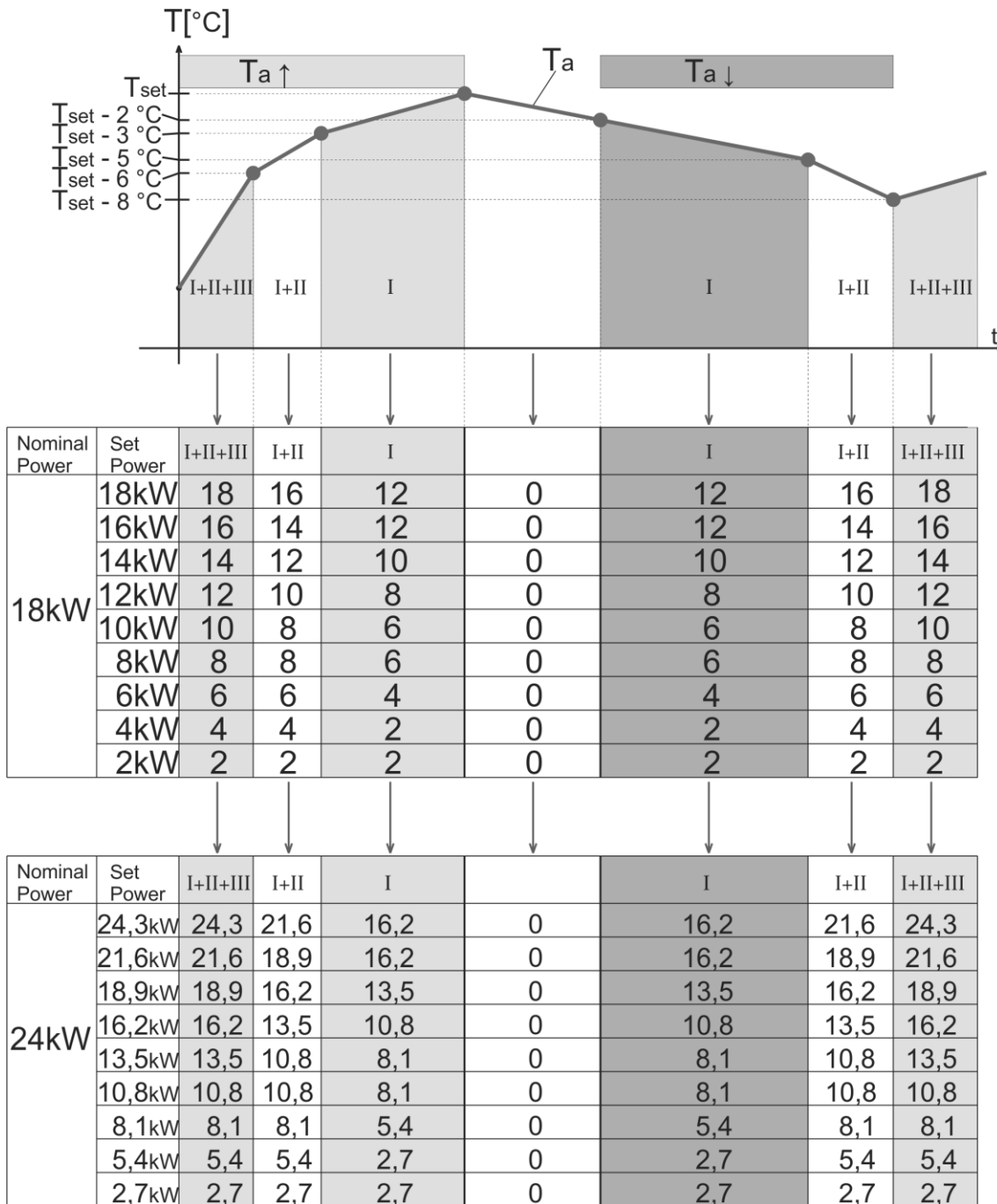

T_{set} – SET value of temperature; T_a – Current temperature; $T_a \uparrow$ - the temperature rises; $T_a \downarrow$ - the temperature drops;

I+II+III – All heating groups is turned on, engaged power is equal to set power;

I+II – Power modulation started, engaged power is reduced, 3. heating group is turned off;

I – Power modulation continue, engaged power is additionally reduced, only 1. heating group is turned on;

Note:

The heating group can consist of one heater, or 2, or 3 heaters, depending on the power of the boiler. Also, the heating groups do not always consist of the same heaters, but are formed from heaters which, at the time of switching on/off, selected by the microcontroller based on the criteria for the minimum operating time of a particular heater, while respecting the symmetric load according to phases.

WARNING codes

- A1** - Warning: approaching the lower limit of the allowed pressure (0.8 bar)
SHOULD BE DONE - Fill the system with water to the necessary pressure
- A2** - Warning: approaching the upper limit of the allowed pressure (2.2 bara)
SHOULD BE DONE - Bring the system to the required pressure
- A3** - Warning: approaching the lower limit of the allowed temperature (5 degrees) of the HEATING SYSTEM
SHOULD BE DONE - Switch on room thermostat and heaters or activate freezing protection regime
- A4** - Warning: approaching the upper limit of the allowed temperature (80 degrees) of the HEATING SYSTEM
SHOULD BE DONE - Lower the power of the boiler, check whether the valves are open

ERROR codes

- E0** - Error: Control system failure - all switched off
- E1** - Error: reached lower limit of the allowed pressure (0.3 bar) – all switched off
REMEDY – Fill the system with water to the necessary pressure, check the sealing of all connections
- E2** - Error: reached upper limit of the allowed pressure (2.6 bar) - all switched off
REMEDY - Bring the system to the required pressure by discharging air and water when needed
- E3** - Error: reached lower limit of the allowed temperature (3°C) - all switched off
- E4** - Error: reached upper limit of the allowed temperature (85°C) – the pump is switched on continuously
REMEDY - Switch off the main fuses for powering the boiler with electricity, call the service center
- E5** - Error: reached lower limit of the allowed temperature of the BOILER (3°C) - INFORMATIVE
- E6** - Error: sensor of temperature of the boiler in break or short circuit - all switched off
REMEDY - Switch off the main fuses for powering the boiler with electricity, call the service center
- E7** - Error: sensor of temperature of the boiler in break or short circuit – no sanitary water preparation
REMEDY - call the service center
- E8** - Error: sensor of pressure in break or short circuit – all switched off
REMEDY - Switch off the main fuses for powering the boiler with electricity, call the service center

Graphical overview of operation of the device based on pressure and temperature

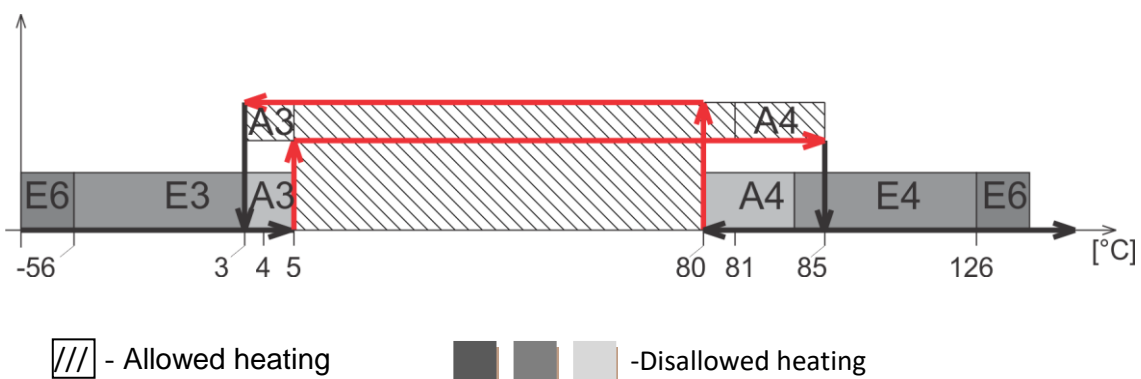
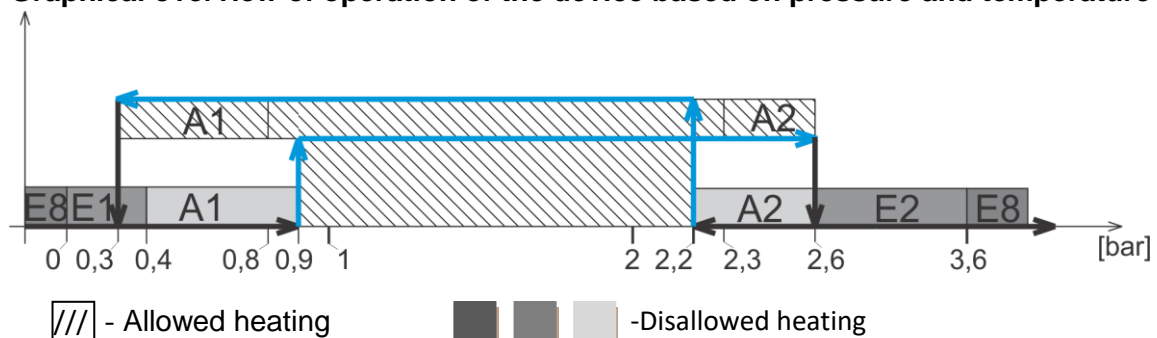

8. Cleaning and maintenance



DANGER: Life danger from electric shock!

- ▶ You can perform electrical works only if you have appropriate qualification.
- ▶ Before opening the device: disconnect the heating system from the power supply by using the safety switch of the heating system and disconnect it from the main network by using an appropriate fuse.
- ▶ Secure the heating installation from involuntary switching on.
- ▶ Comply with the regulations for installation.



WARNING: Material damages caused by unprofessional maintenance!

Insufficient or unprofessional maintenance of the boiler can lead to damages or destruction of the boiler, and thus to loss of warranty right.

- ▶ Ensure regular, thorough and professional maintenance of the heating installation.
- ▶ Protect electrical parts and operating units from water and moisture.



Use only original spare parts of the manufacturer or spare parts that are approved by the manufacturer. No liability is assumed for damages arising from spare parts which are not supplied by the manufacturer.



The inspection and maintenance record is on chapter 8.4 (Table 7).

- ▶ Perform all works according to the inspection and maintenance record.
- ▶ Deficiencies need to be repaired immediately.

8.1 Cleaning the boiler

- ▶ Clean the device on the outside by a damp cloth.

8.2 Check the operating pressure, fill with water and discharge air from the installation



DANGER: Danger to health due to mixing drinking water!

- ▶ Be sure to comply with national regulations and norms for avoiding the mixing of drinking water (eg. with water from heating installations).
- ▶ Comply with EN 1717.



Establish the operating pressure of at least 1 bar, depending on the height of the installation.

The volume of newly filled water decreases in the first days after the filling due to heating. This creates airbags that create interference in the heating system.

Inspection of operating pressure

- ▶ The operating pressure of the new heating installation should be controlled on a daily basis in the beginning. If necessary, add water to the heating system and discharge the air.
- ▶ After that, check the operating pressure once a month. If necessary, add water and discharge air from the heating system.
- ▶ Check the operating pressure. If the pressure of installation drops below 1 bar, it is necessary to fill it with water.
- ▶ Add water.
- ▶ Discharge air from the heating installation.
- ▶ Check again the operating pressure.

8.3 Discharge air from the installation and fill it with water



WARNING: Material damages caused by heat straining. Filling the heating installation in a warm state can cause cracks due to tension.



▶ Fill the heating installation in cold state only (temperature of the starting line maximum 40 °C).



WARNING: Material damages caused by frequent filling!

Due to frequent filling of heating installation with water, it can be damaged by corrosion or by formation of limescale, depending on the properties of water.

▶ Inspect the heating installation for impermeability, and the expansion container for functionality.

- ▶ Connect the hose to the water tap.
- ▶ Fill the hose with water and attach to the hose connector of the tap for charging and discharging.
- ▶ Fasten the hose with the clout of the hose and open the charging and discharging tap.
- ▶ Fill the heating installation slowly and monitor the overview of pressure (manometer).
- ▶ Discharge the air during the filling process.
- ▶ Close the discharging tap when the operating pressure is reached.
- ▶ Water must be refilled when the operating pressure drops due to discharging of air.
- ▶ Remove the hose from the charging and discharging tap.

8.4 Record on inspection and maintenance



Perform maintenance at least once a year, or when the inspection shows the state of installation that requires maintenance.

The record on putting into operation, inspections and maintenance serves as an attachment for copying.

► The performed inspections should be verified by signature and date.

Inspection and maintenance works when needed	Date: _____	Date: _____	Date: _____
1. Check condition of installations	<input type="checkbox"/>	<input type="checkbox"/>	<input type="checkbox"/>
2. Visual and functional control	<input type="checkbox"/>	<input type="checkbox"/>	<input type="checkbox"/>
Making working pressure			
3. • Check pre-pressure of expansion dish	<input type="checkbox"/>	<input type="checkbox"/>	<input type="checkbox"/>
• Working pressure set on ...	_____ bar	_____ bar	_____ bar
• Heating installation air vent	<input type="checkbox"/>	<input type="checkbox"/>	<input type="checkbox"/>
• Check safety heating valve	<input type="checkbox"/>	<input type="checkbox"/>	<input type="checkbox"/>
4. Clean water filter	<input type="checkbox"/>	<input type="checkbox"/>	<input type="checkbox"/>
5. Check if there is any damage on electric duct lines	<input type="checkbox"/>	<input type="checkbox"/>	<input type="checkbox"/>
6. Check if electric control connections and used elements are fitted; tighten it if needed	<input type="checkbox"/>	<input type="checkbox"/>	<input type="checkbox"/>
7. Check thermo-regulator on boiler	<input type="checkbox"/>	<input type="checkbox"/>	<input type="checkbox"/>
8. Check function of safety parts	<input type="checkbox"/>	<input type="checkbox"/>	<input type="checkbox"/>
9. Check remote control function	<input type="checkbox"/>	<input type="checkbox"/>	<input type="checkbox"/>
10. Check insulation of the rod heater	<input type="checkbox"/>	<input type="checkbox"/>	<input type="checkbox"/>
11. Check function of grounding device	<input type="checkbox"/>	<input type="checkbox"/>	<input type="checkbox"/>
12. Check insulation of electric switchboard	<input type="checkbox"/>	<input type="checkbox"/>	<input type="checkbox"/>
13. Check heating pump function	<input type="checkbox"/>	<input type="checkbox"/>	<input type="checkbox"/>
14. Make final control of inspection works and document results of measuring and inspecting	<input type="checkbox"/>	<input type="checkbox"/>	<input type="checkbox"/>
	Seal/Signature	Seal/Signature	Seal/Signature
15. Certification of professionally conducted inspection			

Table 7: Record on inspection and maintenance

9. Environmental protection / disposal into waste

Environmental protection is one of the basic principles of business.

Product quality, cost-effectiveness and environmental protection represent equally worthwhile goals.

It is necessary to strictly comply with the laws and regulations on environmental protection. We use only the best technique and materials for the purpose of protecting the environment and respecting economic principles.

Packaging

When packing, we comply with recycling systems that are specific in certain countries and which ensure optimum recycling. All used packaging materials do not harm the environment and can be recycled.

Old devices

Old devices contain valuable recyclable materials. The assemblies can easily be separated and the plastic materials are marked. In this way, the assemblies can be sorted and taken for recycling, that is, disposal.

10. Faults and their remedy



Remedy of faults on the regulation and hydraulics must be carried out by an authorized company.



Use only original parts for repairs.

FAULT	DESCRIPTION	CAUSE	MEASURE
The boiler does not react after switching on the main switch	The display does not respond, the other components do not work	<ul style="list-style-type: none"> Boiler is disconnected from electricity The fuses on the bottom panel are switched off Possible disappearance of the control phase Fault of the main switch ON/OFF 	<ul style="list-style-type: none"> Ensure power supply voltage Switch on the fuses Check on the fuses if there are all three phases at the exit Replace the defective part
The boiler does not heat or does not heat enough / the heating pump works	Everything on the display is in the recommended limits, but the boiler does not deliver hot water	<ul style="list-style-type: none"> Lack of 1 or 2 phases The power of the boiler is too low Fault in one of the relays Fault in one of the heaters 	<ul style="list-style-type: none"> Check if all three phases come into the boiler Check the set power of the boiler. Replace the defective part
The boiler heats but it is very noisy	Increased noise level during operation	<ul style="list-style-type: none"> Air in the system Too low water flow Possible occurrence of limescale on the heater 	<ul style="list-style-type: none"> Check if the air is discharged from the system and discharge it Check the valves below the boiler and open them Clean the filter in front of the boiler Remove heaters and clean them (this is not considered as a complaint within the warranty period)
The boiler is quickly switching off	It reaches the desired temperature too quickly and stops working	<ul style="list-style-type: none"> Closed valves under the boiler The pump's fuse has stopped working Stuck pump Defective pump 	<ul style="list-style-type: none"> Open the valves Replace the defective part Start the rotor of the pump Replace the defective part
Large oscillations of the operating pressure	Too fast and too large changes in the operating pressure	<ul style="list-style-type: none"> One valve is closed Pressure in the expansion container is inadequate Defective container 	<ul style="list-style-type: none"> Open the valve Check the pressure in the expansion container and pump the container to an adequate value if it is necessary Replace the defective part

Table 8: Faults and their remedy

11. Instructions for designing







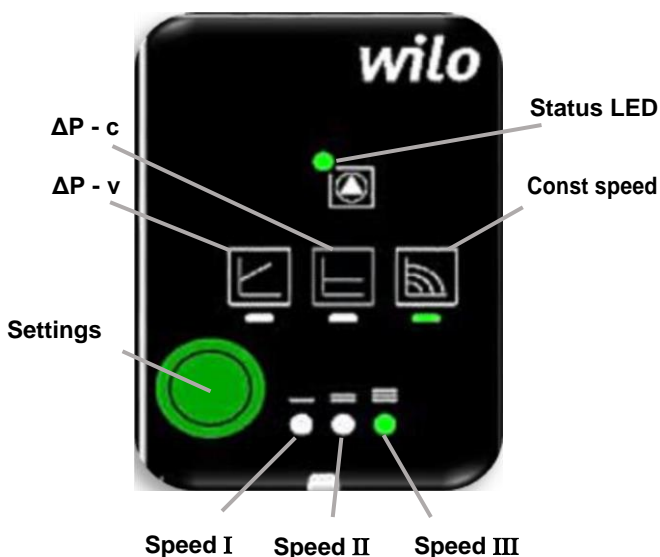

Pump Wilo-Para MSL/6-43/SC

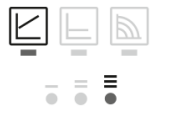

Wilo Para MSL / 6-43 / SC is a circulating pump for heating systems, heating systems for family houses and other similar systems. The most important characteristics of this pump are:

- Maximum flow rate: 2.1 m³ / h
- Maximum water column height: 6.8 m
- Maximum media temperature (at ambient temperature 58 ° C): 100 ° C
- Maximum glycol concentration in the system: 50%
- Minimum and maximum rotor speed: 2430 ~ 4300 rpm
- Minimum and maximum pump power: 3 W ~ 43W
- Minimum and maximum pump current (230V AC): 0.04 4 0.44A
- Energy Efficiency Index (EEI): ≤ 0.2
(This energy efficiency index in practice means that the Wilo-Para pump consumes up to 80% less electricity compared to earlier versions of the same class pumps that did not have electronic power regulation).



	LED display	Control mode	Pump curve
1.		Constant speed	II
2.		Constant speed	I
3.		Variable differential pressure $\Delta p-v$	III
4.		Variable differential pressure $\Delta p-v$	II
5.		Variable differential pressure $\Delta p-v$	I
6.		Constant differential pressure $\Delta p-c$	III
7.		Constant differential pressure $\Delta p-c$	II
8.		Constant differential pressure $\Delta p-c$	I
9.		Constant speed	III

Faults, causes and remedies

The troubleshooting must only be carried out by a qualified specialist, and work on the electrical connection must only be carried out by a qualified electrician.

Faults	Causes	Remedy
Pump is not running although the power supply is switched on	Electrical fuse defective	Check fuses
	No voltage supply at pump	Rectify the power interruption
Noisy pump	Cavitation due to insufficient suction pressure	Increase the system pressure within the permissible range
		Check the delivery head and set it to a lower head if necessary
Building does not warm up	Thermal output of the heating surfaces is too low	Increase setpoint
		Change the control mode from Δp -c to Δp -v

Fault signals

- The fault signal LED indicates a fault.
- The pump switches off (depending on the fault) and attempts a cyclical restart.

LED	Faults	Causes	Remedy
Lights up red	Blocking	Rotor blocked	Activate manual restart or contact customer service
	Contacting/winding	Winding defective	
Flashes red	Under/overvoltage	Power supply too low/high on mains side	Check mains voltage and operating conditions, and request customer service
	Excessive module temperature	Module interior too warm	
	Short-circuit	Motor current too high	
Flashes red/green	Generator operation	Water is flowing through the pump hydraulics, but there is no mains voltage at the pump	Check the mains voltage, water quantity/pressure and the ambient conditions
	Dry run	Air in the pump	
	Overload	Sluggish motor, pump is operated outside of its specifications (e.g. high module temperature). The speed is lower than during normal operation.	

Activating factory setting

The factory setting is activated by pressing and holding the operating button whilst switching off the pump.

- Press and hold the operating button for at least 4 seconds.
- All LEDs flash for 1 second.
- The LEDs for the last setting flash for 1 second.

Decommissioning

Shutting down the pump

Shut down the pump immediately if the connecting cable or other electrical components are damaged.

- Disconnect the pump from the power supply.
- Contact a service technician.

Maintenance

Cleaning

- Carefully remove dirt from the pump on a regular basis using a dry duster.
- Never use liquids or aggressive cleaning agents.

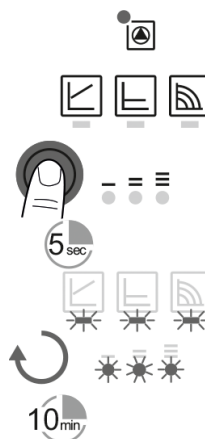

Manual restart

- The pump attempts an automatic restart upon detecting a blockage.
- If the pump does not restart automatically:
 - Activate manual restart via the operating button: press and hold for 5 seconds, then release.
 - The restart function is initiated, and lasts max. 10 minutes.
 - The LEDs flash in succession clockwise.
 - To cancel, press and hold the operating button for 5 seconds.

If the fault cannot be remedied, contact an authorized service center.



NOTICE

After the restart, the LED display shows the previously set values of the pump.



Venting

- Fill and vent the system correctly.
- If the pump does not vent automatically:
 - Activate the pump venting function via the operating button: Press and hold for 3 seconds, then release. The pump venting function is initiated and lasts 10 minutes. The top and bottom LED rows flash in turn at 1 second intervals.
 - To cancel, press and hold the operating button for 3 seconds.



NOTICE

After venting, the LED display shows the previously set values of the pump.



Lock/unlock the button

- To activate the key lock, press and hold the operating button for 8 seconds until the LEDs for the selected setting briefly flash, then release.
 - LEDs flash constantly at 1-second intervals.
 - The key lock is activated: pump settings can no longer be changed.
- The key lock is deactivated in the same manner as it is activated.





NOTICE

All settings/displays are retained if the power supply is interrupted.

12. Product data sheet (in accordance with EU regulation no. 811/2013)

1.	Manufacturer		MIKOTERM DOO
2.	Brand name		eTronic 7000
3.	Models	I	eTronic 7000 6kW
		II	eTronic 7000 9kW
		III	eTronic 7000 12kW
		IV	eTronic 7000 18kW
		V	eTronic 7000 24kW

				I	II	III	IV	V
4.	Room heating: Seasonal energy-efficiency class			D	D	D	D	D
5.	Room heating: Nominal heat output(*8) (*11)	P_{rated}	kW	6	9	12	18	24
6.	Room heating: Seasonal energy efficiency(*8)	η_s	%	99	99	99	99	99
7.	Annual energy consumption(*8)	Q_{HE}	kWh	6600	11022	13266	22088	28756
8.	Sound power level, indoor	$L_{WA, indoor}$	dB(A)	3	3	3	3	3
9.	 <p>All specific precautions for assembly, installation and maintenance are described in the operating and installation instructions. Read and follow the operating and installation instructions.</p>							
10.	 <p>All of the data that is included in the product information was determined by applying the specifications of the relevant European directives. Differences to product information listed elsewhere may result in different test conditions. Only the data that is contained in this product information is applicable and valid.</p>							

(*8) For average climatic conditions

(*11) For boilers and combination boilers with a heat pump, the nominal heat output "Prated" is the same as the design load in heating mode "Pdesignh", and the nominal heat output for an auxiliary boiler "Psup" is the same as the additional heating output "sup(Tj)"

MIKOTERM d.o.o.

Bulevar Svetog Cara Konstantina 82

18000 Niš - Serbia

Tel.: +381 (18) 45 42 002; 34 09 702; 34 09 703;

e-mail: prodaja@mikoterm.com; office@mikoterm.com

www.mikoterm.com

This document is the property of MIKOTERM d.o.o. and any duplication and copying thereof is punishable by law. The contents of technical documentation and technical solutions from this manual are protected by intellectual property of MIKOTERM d.o.o. Any unauthorized use, copying or publication, in whole or in part, by other entities without the authorization of MIKOTERM d.o.o. is punishable by law.

Nis, 2019

Mikoterm d.o.o. does not assume responsibility for possible errors in this booklet produced by printing or duplication, all images and schemes are in principle, it is necessary to adapt each to the actual situation on the ground. In any case, Mikoterm reserves the right to make changes that it deems necessary on its products.